

ORIGINAL GARDEN



UNCONVENTIONAL GARDEN

RECO +70% RECYCLED

2025
General Catalogue

01/ TAP CONNECTORS

A range of sizes, for every type of tap, perfect for easily connecting quick-click connectors.



Threaded tap connector

- Internal screw thread for tap
- Grabbing surface
- Male connection to connect to the hose terminal



Threaded tap connector

- Internal screw thread for tap
- Grabbing surface
- Male connection to connect to the hose terminal



Threaded tap connector

- Internal screw thread for tap
- Grabbing surface
- Male connection to connect to the hose terminal



GF80005484	
Box (LxWxH) cm 20,7x14,7x10,4	
Pcs 10	
Kg 0,31	8 004779 005213



GF80005433	
Box (LxWxH) cm 20,7x14,7x10,4	
Pcs 10	
Kg 0,28	8 004779 054334



GF80005432	
Box (LxWxH) cm 20,7x14,7x10,4	
Pcs 10	
Kg 0,31	8 004779 054327

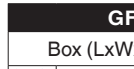

GF80003433	
Box (LxWxH) cm 15x15x12	
Pcs 25	
Kg 0,28	

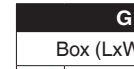

GF80003432	
Box (LxWxH) cm 15x15x12	
Pcs 25	
Kg 0,32	



GF80043433	
Box (LxWxH) cm 40x12,8x14	
Pcs 70	
Kg 0,82	8 004779 034336



GF80043432	
Box (LxWxH) cm 40x12,8x14	
Pcs 70	
Kg 0,91	8 004779 034329



Threaded tap connector

- Internal screw thread for tap
- Grabbing surface
- Male connection to connect to the hose terminal



Threaded tap connector

- Internal screw thread for tap
- Grabbing surface
- Male connection to connect to the hose terminal



Threaded tap connector with kitchen and bath adapter

Connector with a threaded bronze coupling of 3/4" gas and M24x1 ext. + M22x1 int.



Smooth tap connector

To link the programmer to taps without threads.



GF80005435	
Box (LxWxH) cm 20,7x14,7x10,4	
Pcs 10	
Kg 0,34	8 004779 054358

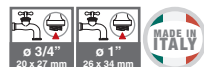

GF80005436	
Box (LxWxH) cm 20,7x14,7x10,4	
Pcs 10	
Kg 0,41	8 004779 003387



GF80002431	
Box (LxWxH) cm 20,7x14,7x10,4	
Pcs 10	
Kg 0,62	8 004779 007804



GF80005440	
Box (LxWxH) cm 20,7x14,7x10,4	
Pcs 10	
Kg 0,42	8 004779 054402



GF80003435	
Box (LxWxH) cm 15x15x12	
Pcs 25	
Kg 0,43	



GF80003436	
Box (LxWxH) cm 15x15x12	
Pcs 25	
Kg 0,58	

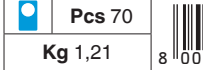

GF80043435	
Box (LxWxH) cm 40x12,8x14	
Pcs 70	
Kg 1,21	8 004779 034350

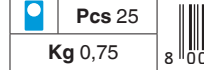

GF80043436	
Box (LxWxH) cm 40x12,8x14	
Pcs 25	
Kg 0,75	8 004779 003400



GF80043440	
Box (LxWxH) cm 40x12,8x14	
Pcs 50	
Kg 1,20	8 004779 034404



Smooth tap connector

To link the programmer to taps without threads. With a metal clamp having a butterfly handle for secure use.



GF80005446	
Box (LxWxH) cm 22,7x15,2x15,4	
Pcs 10	
Kg 0,78	8 004779 054464



Swivel tap connector

Swivel tap connector with 180° joint to connect the hose to the tap, to avoid kinks during use.
• 3/4" (20-27mm) tap connector

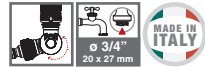

GF80005074	
Box (LxWxH) cm 30x24,5x11,7	
Pcs 10	
Kg 0,90	8 004779 036682



Dual outlet tap connector

Dual outlet tap connector with differentiated water flow adjustment.
Flow-rate regulator-modulator for each outlet to adjust separately the flow rate until the total closing.
Useful for coupling more accessories simultaneously.



GF80005073	
Box (LxWxH) cm 37x24x19,5	
Pcs 8	
Kg 1,50	8 004779 022999



Multi-outlet distributor for threaded taps

5 separate adjustable connections to link to hose connectors or programmers.
Has 3 adjustable ball-cocks.



GF80005072	
Box (LxWxH) cm 37,5x25,5x15,5	
Pcs 4	
Kg 1,21	8 004779 000409

GF80043446	
Box (LxWxH) cm 40x12,8x14	
Pcs 25	
Kg 1,67	8 004779 034466

GF80043074	
Box (LxWxH) cm 39x24x13,5	
Pcs 30	
Kg 1,75	8 004779 036692

GF80043073	
Box (LxWxH) cm 40x24,8x14	
Pcs 8	
Kg 1,50	8 004779 023002



Ball-cock with flow control

With threaded 3/4" female connection it can be used for attaching hose connectors to the 5-outlet distributor.



Tap adaptor

Adaptor having 1" female and 3/4" male.

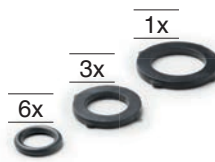

Seals and o-rings kit

- 6 pcs. O-Rings for standard shanks
- 3 flat Seals of 3/4" (ø 20-27 mm)
- 1 flat Seal of 1" (ø 26-34 mm)



Hydro-Garden CFS 3" filter kit

For the protection of irrigation systems, or for washing machines, boilers and other installations.
• washable cartridge and filter unit in mesh
• applications: filtering of sand, flakes, mud, and fine material



GF80005001	
Box (LxWxH) cm 22,7x15,2x15,4	
Pcs 10	
Kg 0,49	8 004779 000423



GF80003447	
Box (LxWxH) cm 15x15x12	
Pcs 10	
Kg 0,22	



GF80005699	
Box (LxWxH) cm 20,7x14,7x10,4	
Pcs 10	
Kg 0,28	8 004779 056994



GF800050106	
Box (LxWxH) cm 38x29x57	
Pcs 96	
Kg 11,80	8 004779 001062

GF80043001	
Box (LxWxH) cm 40x12,8x14	
Pcs 20	
Kg 0,70	8 004779 000430

GF80050109	
Box (LxWxH) cm 38x29x57	
Pcs 96	
Kg 11,80	8 004779 000614

GF80000109	
Box (LxWxH) cm 37x24x20	
Pcs 12	
Kg 1,70	8 004779 001093

02/ CONNECTORS

Practical and simple to use, "open" click connectors for connecting the tap connector to the hose, or with "acquastop" connector to connect accessories without dripping and without turning off the tap. The soft touch version with its soft rubber cover guarantees a perfect grip and an ergonomic design suitable for any use.



"OPEN" hose connector

For click-fitting the hose to the tap connector. Uninterrupted water passage.



"ACQUASTOP" hose connector

For click-fitting the hose to various irrigation accessories. Automatic water stop-valve.



"OPEN" hose connector

For click-fitting the hose to the tap connector. Uninterrupted water passage.



GF80005020	
Box (LxWxH) cm 22,7x15,2x15,4	
Pcs 10	
Kg 0,49	8 004779 050206

GF80003020	
Box (LxWxH) cm 20,7x14,7x10,4	
Pcs 25	
Kg 0,77	

GF80043020	
Box (LxWxH) cm 40x24,8x14	
Pcs 60	
Kg 1,98	8 004779 030208



GF80005015	
Box (LxWxH) cm 22,7x15,2x15,4	
Pcs 10	
Kg 0,50	8 004779 050152

GF80003015	
Box (LxWxH) cm 20,7x14,7x10,4	
Pcs 25	
Kg 0,79	

GF80043015	
Box (LxWxH) cm 40x24,8x14	
Pcs 60	
Kg 2,07	8 004779 030154



GF80005023	
Box (LxWxH) cm 22,7x15,2x15,4	
Pcs 10	
Kg 0,51	8 004779 050237

GF80003023	
Box (LxWxH) cm 22,7x15,2x15,4	
Pcs 25	
Kg 0,95	

GF80043023	
Box (LxWxH) cm 40x24,8x14	
Pcs 60	
Kg 2,37	8 004779 030239



"ACQUASTOP" hose connector

For click-fitting the hose to various irrigation accessories. Automatic water stop-valve.



"Open" universal hose connector

Can be used with hoses of any diameter. To click-fit the hose to the tap connector. Uninterrupted water passage.



"ACQUASTOP" universal hose connector

Can be used with hoses of any diameter. To click-fit the hose to various irrigation accessories. Automatic water stop-valve.



Hose connector with tap

Fitted at the end of the hose, it can adjust the water flow delivered by the attached irrigator.



GF80005012	
Box (LxWxH) cm 22,7x15,2x15,4	
Pcs 10	
Kg 0,58	8 004779 050121

GF80003012	
Box (LxWxH) cm 22,7x15,2x15,4	
Pcs 25	
Kg 0,98	

GF80043012	
Box (LxWxH) cm 40x24,8x14	
Pcs 60	
Kg 3,76	8 004779 030123



GF80005027	
Box (LxWxH) cm 22,7x15,2x15,4	
Pcs 10	
Kg 0,63	8 004779 050275

GF80003027	
Box (LxWxH) cm 22,7x15,2x15,4	
Pcs 25	
Kg 1,11	

GF80043027	
Box (LxWxH) cm 40x24,8x14	
Pcs 60	
Kg 2,77	8 004779 030277



GF80005017	
Box (LxWxH) cm 22,7x15,2x15,4	
Pcs 10	
Kg 0,64	8 004779 050176

GF80003017	
Box (LxWxH) cm 22,7x15,2x15,4	
Pcs 25	
Kg 1,20	

GF80043017	
Box (LxWxH) cm 40x24,8x14	
Pcs 60	
Kg 2,89	8 004779 030178



GF80005029	
Box (LxWxH) cm 30x24,5x11,7	
Pcs 10	
Kg 0,90	8 004779 016721

GF80003029	
Box (LxWxH) cm 23x15,5x15,7	
Pcs 25	
Kg 1,43	

GF80043029	
Box (LxWxH) cm 40x24,8x14	
Pcs 30	
Kg 1,75	8 004779 016745



Hose connector with tap

Fitted at the end of the hose, it can adjust the water flow delivered by the attached irrigator.



Repair connector

For repairing damaged hoses or joining two hoses.



Repair connector

For repairing damaged hoses or joining two hoses.



“Universal” repair connector

Usable with hoses of any diameter. For repairing damaged hoses or joining two hoses.



GF80005024	
Box (LxWxH) cm 30x24,5x11,7	
Pcs 10	
Kg 0,80	8 004779 016691



GF80005439	
Box (LxWxH) cm 20,7x14,7x10,4	
Pcs 10	
Kg 0,37	8 004779 054396



GF80005437	
Box (LxWxH) cm 22,7x15,2x15,4	
Pcs 10	
Kg 0,54	8 004779 054372



GF80005443	
Box (LxWxH) cm 22,7x15,2x15,4	
Pcs 10	
Kg 0,68	8 004779 000386

GF80003024	
Box (LxWxH) cm 23x15,5x15,7	
Pcs 25	
Kg 1,25	

GF80003439	
Box (LxWxH) cm 15x15x12	
Pcs 25	
Kg 0,51	

GF80003437	
Box (LxWxH) cm 22,5x18,5x9	
Pcs 25	
Kg 0,89	

GF80003443	
Box (LxWxH) cm 22,7x15,2x15,4	
Pcs 25	
Kg 1,26	

GF80043024	
Box (LxWxH) cm 40x24,8x14	
Pcs 30	
Kg 1,60	8 004779 016714

GF80043439	
Box (LxWxH) cm 40x12,8x14	
Pcs 40	
Kg 0,94	8 004779 034398

GF80043437	
Box (LxWxH) cm 40x12,8x14	
Pcs 35	
Kg 1,35	8 004779 034374

GF80043443	
Box (LxWxH) cm 40x24,8x14	
Pcs 40	
Kg 2,18	8 004779 000393



Two-way connector

For interconnecting TWO hose lines equipped with snap-fit hose connectors.



Three-way connector

For interconnecting THREE hose lines equipped with snap-fit hose connectors.



Threaded adaptor connector with male junction.

Allows hoses equipped with click connectors to be linked with irrigators having a female threaded inlet of 3/4" gas (ø 20-27 mm).



GF80005450	
Box (LxWxH) cm 20,7x14,7x10,4	
Pcs 10	
Kg 0,29	8 004779 054501



GF80005451	
Box (LxWxH) cm 20,7x14,7x10,4	
Pcs 10	
Kg 0,35	8 004779 054518



GF80005429	
Box (LxWxH) cm 14,5x14,5x11	
Pcs 10	
Kg 0,27	8 004779 054297

GF80003450	
Box (LxWxH) cm 15x15x12	
Pcs 25	
Kg 0,29	

GF80003451	
Box (LxWxH) cm 15x15x12	
Pcs 25	
Kg 0,45	

GF80003429	
Box (LxWxH) cm 15x15x12	
Pcs 25	
Kg 0,24	

GF80043450	
Box (LxWxH) cm 40x12,8x14	
Pcs 70	
Kg 0,84	8 004779 034503

GF80043451	
Box (LxWxH) cm 40x12,8x14	
Pcs 70	
Kg 1,26	8 004779 034510

GF80043429	
Box (LxWxH) cm 40x12,8x14	
Pcs 50	
Kg 0,58	8 004779 034299





“OPEN” hose connector

For click-fitting the hose to the tap connector.
Uninterrupted water passage.



“ACQUASTOP” hose connector

For click-fitting the hose to various irrigation accessories. Automatic water stop-valve.

NEW



Open hose connector with Metal Nut

For click-fitting the hose to the tap connector.
Uninterrupted water passage.
Corrosion-resistant metal nut.

NEW



Acquastop hose connector with Metal Nut

For click-fitting the hose to various irrigation accessories.
Automatic water stop-valve.
Corrosion-resistant metal nut.



GF80005042

Box (LxWxH) cm 22,7x15,2x15,4

	Pcs 10	
Kg 0,50		



GF80005043

Box (LxWxH) cm 22,7x15,2x15,4

	Pcs 10	
Kg 0,51		



GF80006710

Box (LxWxH) cm 22,7x15,2x15,4

	Pcs 10	
Kg 1,00		



GF80006711

Box (LxWxH) cm 22,7x15,2x15,4

	Pcs 10	
Kg 1,00		

GF80043042		
Box (LxWxH) cm 40x24,8x14		
	Pcs 50	
Kg 1,69		

GF80043043		
Box (LxWxH) cm 40x24,8x14		
	Pcs 50	
Kg 1,80		

GF80043710		
Box (LxWxH) cm 40x24,8x14		
	Pcs 50	
Kg 3,20		

GF80043711		
Box (LxWxH) cm 40x24,8x14		
	Pcs 50	
Kg 3,20		



“OPEN” hose connector

For click-fitting the hose to the tap connector.
Uninterrupted water passage.



“ACQUASTOP” hose connector

For click-fitting the hose to various irrigation accessories. Automatic water stop-valve.

NEW



Open hose connector with Metal Nut

For click-fitting the hose to the tap connector.
Uninterrupted water passage.
Corrosion-resistant metal nut.

NEW



Acquastop hose connector with Metal Nut

For click-fitting the hose to various irrigation accessories.
Automatic water stop-valve.
Corrosion-resistant metal nut.



GF80005044

Box (LxWxH) cm 22,7x15,2x15,4

	Pcs 10	
Kg 0,57		



GF80005045

Box (LxWxH) cm 22,7x15,2x15,4

	Pcs 10	
Kg 0,58		



GF80006712

Box (LxWxH) cm 22,7x15,2x15,4

	Pcs 10	
Kg 1,6		



GF80006713

Box (LxWxH) cm 22,7x15,2x15,4

	Pcs 10	
Kg 1,6		

GF80043044		
Box (LxWxH) cm 40x24,8x14		
	Pcs 50	
Kg 2,05		

GF80043045		
Box (LxWxH) cm 40x24,8x14		
	Pcs 50	
Kg 2,35		

GF80043712		
Box (LxWxH) cm 40x24,8x14		
	Pcs 50	
Kg 6,70		

GF80043713		
Box (LxWxH) cm 40x24,8x14		
	Pcs 50	
Kg 6,70		



**"Open"
universal hose connector**

Can be used with hoses of any diameter.
To click-fit the hose to the tap connector.
Uninterrupted water passage.



**"ACQUASTOP"
universal hose connector**

Can be used with hoses of any diameter.
To click-fit the hose to various irrigation accessories.
Automatic water stop-valve.



GF80005046	
Box (LxWxH) cm 22,7x15,2x15,4	
Pcs 10	
Kg 0,64	8 004779 003325



GF80005047	
Box (LxWxH) cm 22,7x15,2x15,4	
Pcs 10	
Kg 0,66	8 004779 003356

GF80043046	
Box (LxWxH) cm 40x24,8x14	
Pcs 50	
Kg 2,30	8 004779 003349

GF80043047	
Box (LxWxH) cm 40x24,8x14	
Pcs 50	
Kg 2,47	8 004779 003370



**03/
HIGH FLOW LINE**



Threaded tap connector

For click-fitting the hose connector to the tap.



“OPEN” hose connector

For click-fitting the hose to the tap connector. Uninterrupted water passage.



“OPEN” hose connector

For click-fitting the hose to the tap connector. Uninterrupted water passage.

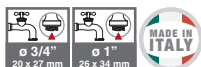

GF80005434	
Box (LxWxH) cm 22,7x15,2x15,4	
Pcs 10	
Kg 0,55	8 004779 000539

GF80043434	
Box (LxWxH) cm 40x12,8x14	
Pcs 25	
Kg 0,99	8 004779 000546



GF80005040	
Box (LxWxH) cm 29,7x24,2x11,4	
Pcs 8	
Kg 0,95	8 004779 000492

GF80043040	
Box (LxWxH) cm 40x24,8x14	
Pcs 20	
Kg 1,98	8 004779 000508



GF80005041	
Box (LxWxH) cm 29,7x24,2x11,4	
Pcs 8	
Kg 0,95	8 004779 003417

GF80043041	
Box (LxWxH) cm 40x24,8x14	
Pcs 20	
Kg 1,97	8 004779 003424



Tap adaptor

Female thread of 1 1/4", male thread of 1".



Repair connector

For repairing damaged hoses or joining two hoses.



Repair connector

For repairing damaged hoses or joining two hoses.



Repair connector

For repairing damaged hoses or joining two hoses.



GF80003448	
Box (LxWxH) cm 15x15x12	
Pcs 10	
Kg 0,55	8 004779 003240



GF80005442	
Box (LxWxH) cm 29,7x24,2x11,4	
Pcs 8	
Kg 0,93	8 004779 000515

GF80043442	
Box (LxWxH) cm 40x24,8x14	
Pcs 20	
Kg 1,91	8 004779 000522



GF80005441	
Box (LxWxH) cm 29,7x24,2x11,4	
Pcs 8	
Kg 0,90	8 004779 003431

GF80043441	
Box (LxWxH) cm 40x24,8x14	
Pcs 20	
Kg 1,89	8 004779 003448

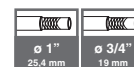

GF80005054	
Box (LxWxH) cm 29,7x24,2x11,4	
Pcs 8	
Kg 0,90	8 004779 017797

GF80043054	
Box (LxWxH) cm 40x24,8x14	
Pcs 20	
Kg 1,90	8 004779 017803



2-Way connector

To join TWO lengths of hose equipped with high flow click connectors.



2-Way connector

To join a hose with high flow connection to a hosepipe with a standard connector.



Mixed "y" coupling

To join a high flow hose line to two lines of hose having standard connections.



"Y" coupling

To join three hoses with high flow connectors.



GF80005452	
Box (LxWxH) cm 22,7x15,2x15,4	
	Pcs 10
Kg 0,39	
8 004779 000577	
GF80043452	
Box (LxWxH) cm 40x12,8x14	
	Pcs 40
Kg 0,96	
8 004779 000584	



GF80005453	
Box (LxWxH) cm 20,7x14,7x10,4	
	Pcs 10
Kg 0,35	
8 004779 0004780	
GF80043453	
Box (LxWxH) cm 40x12,8x14	
	Pcs 40
Kg 0,77	
8 004779 005251	



GF80005455	
Box (LxWxH) cm 22,7x15,2x15,4	
	Pcs 10
Kg 0,44	
8 004779 004803	
GF80043455	
Box (LxWxH) cm 40x12,8x14	
	Pcs 30
Kg 0,90	
8 004779 005299	



GF80005454	
Box (LxWxH) cm 22,7x15,2x15,4	
	Pcs 10
Kg 0,55	
8 004779 0004797	
GF80043454	
Box (LxWxH) cm 40x12,8x14	
	Pcs 20
Kg 0,91	
8 004779 005275	



Threaded adaptor with male connection

Allows for linking a hose with a click fitting to pumps and sprinklers with a threaded female water inlet of 1"gas (ø 26 - 34 mm).



Spray nozzle

With jet adjustment from direct to fine spray cone. Male connection for linking to high-flow hose connectors. Max. flow 40 l/min at 3 bar.



Spray nozzle kit

- Spray nozzle
- "OPEN" hose connector



GF80005445	
Box (LxWxH) cm 22,7x15,2x15,4	
	Pcs 10
Kg 0,38	
8 004779 002007	
GF80043445	
Box (LxWxH) cm 40x12,8x14	
	Pcs 25
Kg 0,67	
8 004779 002021	

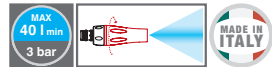

GF80005408	
Box (LxWxH) cm 37,5x25,5x15,5	
	Pcs 6
Kg 1,06	
8 004779 000553	
GF80043408	
Box (LxWxH) cm 40x24,8x14	
	Pcs 15
Kg 2,01	
8 004779 000560	



GF80005008	
Box (LxWxH) cm 37,5x25,5x15,5	
	Pcs 6
Kg 1,70	
8 004779 025143	



**04/
METAL LINE**



Threaded tap connector

For click-fitting the hose connector to the tap



Threaded tap connector

For click-fitting the hose connector to the tap



Dual outlet threaded tap connector

With two independent water outlets and tap to regulate the flow, open/closed. For connecting two lines of hose with Click connections.



GF80002433	
Box (LxWxH) cm 20,7x14,7x10,4	
Pcs 10	
Kg 0,60	8 004779 024337



GF80002432	
Box (LxWxH) cm 22,7x15,2x15,4	
Pcs 10	
Kg 0,74	8 004779 024320



GF80002070	
Box (LxWxH) cm 29,7x24,2x11,4	
Pcs 8	
Kg 2,57	8 004779 000478



GF80041433	
Box (LxWxH) cm 17,5x7,5x7,5	
Pcs 10	
Kg 0,49	8 004779 014338



GF80041432	
Box (LxWxH) cm 17,5x7,5x7,5	
Pcs 10	
Kg 0,53	8 004779 014321



GF80041070	
Box (LxWxH) cm 20,7x14,7x10,4	
Pcs 10	
Kg 2,90	8 004779 000485



“OPEN” hose connector

For click-fitting the hose to the tap connector. Uninterrupted water passage.



“ACQUASTOP” hose connector

For click-fitting the hose to various irrigation accessories. Automatic water stop-valve.



“OPEN” hose connector

For click-fitting the hose to the tap connector. Uninterrupted water passage.



“ACQUASTOP” hose connector

For click-fitting the hose to various irrigation accessories. Automatic water stop-valve.



GF80002020	
Box (LxWxH) cm 22,7x15,2x15,4	
Pcs 10	
Kg 1,29	8 004779 020209



GF80002015	
Box (LxWxH) cm 22,7x15,2x15,4	
Pcs 10	
Kg 1,31	8 004779 020155



GF80002023	
Box (LxWxH) cm 22,7x15,2x15,4	
Pcs 10	
Kg 1,69	8 004779 020230



GF80002012	
Box (LxWxH) cm 22,7x15,2x15,4	
Pcs 10	
Kg 1,76	8 004779 020124



GF80041020	
Box (LxWxH) cm 26x7,5x7,5	
Pcs 10	
Kg 1,12	8 004779 010200



GF80041015	
Box (LxWxH) cm 26x7,5x7,5	
Pcs 10	
Kg 1,22	8 004779 010156



GF80041023	
Box (LxWxH) cm 26x7,5x7,5	
Pcs 10	
Kg 1,51	8 004779 010231



GF80041012	
Box (LxWxH) cm 26x7,5x7,5	
Pcs 10	
Kg 1,61	8 004779 010125



Repair connector

For repairing damaged hoses or joining two hoses.



Repair connector

For repairing damaged hoses or joining two hoses.



Two-way connector

For joining TWO hosepipes equipped with snap-fit hose connectors.



Three-way connector

For joining THREE hosepipes equipped with snap-fit hose connectors.



ø 1/2"-5/8"
12 - 15 mm

GF80002439

Box (LxWxH) cm 22,7x15,2x15,4

Pcs 10
Kg 1,25



ø 3/4"
16 - 19 mm

GF80002437

Box (LxWxH) cm 22,7x15,2x15,4

Pcs 10
Kg 2,03



GF80002450

Box (LxWxH) cm 20,7x14,7x10,4

Pcs 10
Kg 0,68



GF80002451

Box (LxWxH) cm 20,7x14,7x10,4

Pcs 10
Kg 1,43



GF80041439

Box (LxWxH) cm 26x7,5x7,5

Pcs 10
Kg 0,95



GF80041437

Box (LxWxH) cm 26x7,5x7,5

Pcs 10
Kg 1,87



GF80041450

Box (LxWxH) cm 17,5x7,5x7,5

Pcs 10
Kg 0,52



GF80041451

Box (LxWxH) cm 17,5x7,5x7,5

Pcs 10
Kg 1,20



Threaded adaptor with male connection

For coupling a hose equipped with a click-fitting to sprinklers with a threaded female water inlet of 3/4" gas (ø 20-27 mm).



Adjustable hose nozzle in brass and rubber

Has jet adjustment from fine spray cone to direct jet. Delivers up to 18l/min at 4 bars of pressure.



4 piece kit in brass and rubber

Composed of: adjustable spray nozzle, tap connector for 3/4" hose connector and "ACQUASTOP" hose connector for hoses from 1/2"-5/8".



ø 3/4" GAS
20 x 27 mm

GF80002429

Box (LxWxH) cm 20,7x14,7x10,4

Pcs 10
Kg 0,59

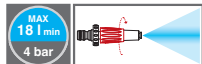

MAX 18 l min
4 bar

GF80002405

Box (LxWxH) cm 29,7x24,2x11,4

Pcs 10
Kg 1,71

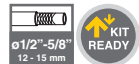

ø 1/2"-5/8"
12 - 15 mm



GF80002422

Box (LxWxH) cm 37,5x25,5x15,5

Pcs 10
Kg 4,43



GF80041429

Box (LxWxH) cm 17,5x7,5x7,5

Pcs 10
Kg 0,43



GF80041405

Box (LxWxH) cm 26x7,5x7,5

Pcs 10
Kg 1,41





05/

NOZZLES AND ERGONOMIC NOZZLES

Easy-to-use, accurate and efficient spray nozzles for perfectly watering flowers and plants. Lightweight, compact and easy to handle, the simple and practical design makes them ideal for easy watering in total comfort.

“8 JET” variable flow rate ergonomic nozzle

- “8 JET” circular selector jet, with grooved edge to make easier its use
- Flow-rate regulator-modulator covered in non-slip soft rubber
- Maximum flow 18 l/min at 4 bar

“3 JET” variable flow rate ergonomic nozzle

- “3 JET” jet selector: fixed, fanned-or-coned-type
- Flow-rate regulator-modulator covered in non-slip soft rubber
- Maximum flow 18 l/min at 4 bar

Medium flow spray nozzle

- Jet adjustment from conical spray to direct jet.
- Flow adjustment
- Maximum flow 18 l/min at 4 bar.

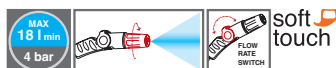
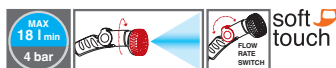

GF80005528	
Box (LxWxH) cm 29,7x24,2x11,4	
Pcs 8	
Kg 1,30	8 004779 019098

GF80005527	
Box (LxWxH) cm 29,7x24,2x11,4	
Pcs 8	
Kg 1,15	8 004779 019074

GF80005404	
Box (LxWxH) cm 37,5x25,5x15,5	
Pcs 8	
Kg 0,97	8 004779 005152

GF80043528	
Box (LxWxH) cm 40x25x14,5	
Pcs 16	
Kg 2,25	8 004779 019104

GF80043527	
Box (LxWxH) cm 40x25x14,5	
Pcs 20	
Kg 2,35	8 004779 019081

GF80043404	
Box (LxWxH) cm 40x24,8x14	
Pcs 30	
Kg 2,27	8 004779 005206





Medium flow spray nozzle

- Jet adjustment from conical spray to direct jet
- Flow adjustment
- Maximum flow 18 l/min at 4 bar



Medium flow nozzle kit

- Medium flow spray nozzle
- 3/4" tap connector
- "OPEN" and "ACQUASTOP" hose connectors



Spray nozzle

- Jet adjustment from fine spray cone to direct jet
- Maximum flow 12 l/min at 4 bar



Spray nozzle kit

- Spray nozzle
- "ACQUASTOP" hose connector

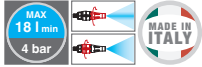

GF80005407

Box (LxWxH) cm **37,5x25,5x15,5**

	Pcs 8	
Kg 0,93	8 004779 054075	



GF80005427

Box (LxWxH) cm **37,5x25,5x15,5**

	Pcs 6	
Kg 1,14	8 004779 054273	

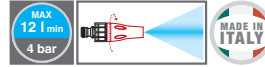

GF80005405

Box (LxWxH) cm **22,7x15,2x15,4**

	Pcs 10	
Kg 0,62	8 004779 054051	



GF80005402

Box (LxWxH) cm **29,7x24,2x11,4**

	Pcs 10	
Kg 0,91	8 004779 054020	

GF80003407

Box (LxWxH) cm **29,7x24,2x11,4**

	Pcs 20
Kg 1,34	

GF80003405

Box (LxWxH) cm **20,7x14,7x10,4**

	Pcs 25
Kg 0,74	

GF80043407

Box (LxWxH) cm **40x24,8x14**

	Pcs 30	
Kg 2,10	8 004779 034077	

GF80043405

Box (LxWxH) cm **40x24,8x14**

	Pcs 50	
Kg 1,64	8 004779 034053	



Medium size spray nozzle

- Jet adjustment from fine spray cone to direct jet
- Maximum flow 14 l/min at 4 bar



Spray nozzle kit

- Spray nozzle
- 3/4" tap connector
- "OPEN" and "ACQUASTOP" hose connectors



Spray nozzle kit

- Spray nozzle
- 3/4" tap connector
- "OPEN" and "ACQUASTOP" universal hose connectors

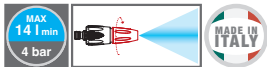

GF80005400

Box (LxWxH) cm **29,7x24,2x11,4**

	Pcs 10	
Kg 0,80	8 004779 009846	



GF80005422

Box (LxWxH) cm **37,5x25,5x15,5**

	Pcs 10	
Kg 1,42	8 004779 054228	



GF80005444

Box (LxWxH) cm **37,5x25,5x15,5**

	Pcs 10	
Kg 1,74	8 004779 003738	

GF80043400

Box (LxWxH) cm **40x24,8x14**

	Pcs 30	
Kg 1,77	8 004779 009839	

06/ SPRAY GUNS

Essential accessories to use the water in the specific and exact way, without wastes and efforts. Essential and compact design to obtain maximum efficiency and simplicity of use.



Medium flow rate watering gun "3 JET"

- Flow rate regulator-modulator with soft non-slip rubber covering
- Front lever with locking device
- "3-JET" selector: fixed, fan and cone jet
- Max. flow rate 20 l/min at 4 bar



Medium flow rate watering gun "3 JET METAL"

- Rugged metal structure with preventive anti-corrosion treatment
- Flow rate regulator-modulator with soft non-slip rubber covering
- Front lever with locking device
- "3-JET" selector: fixed, fan and cone jet
- Max. flow rate 20 l/min at 4 bar



Watering gun

- Handle with soft non-slip rubber covering
- Rear adjustment lever to lock the jet.
- Outlet control from fine atomized spray to concentrated jet.
- Maximum flow rate 12 l/min at 4 bar.

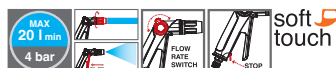

GF80006903	
Box (LxWxH) cm	36x21,7x12
Pcs	6
Kg	1,27
8 004779 033674	

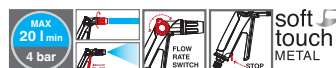

GF80006902	
Box (LxWxH) cm	36x21,7x12
Pcs	6
Kg	2,00
8 004779 033650	



GF80006922	
Box (LxWxH) cm	29,7x24,4x11,4
Pcs	8
Kg	1,95
8 004779 040047	

GF80043903	
Box (LxWxH) cm	40x24,8x14,5
Pcs	10
Kg	1,50
8 004779 033681	

GF80043902	
Box (LxWxH) cm	40x24,8x14,5
Pcs	6
Kg	1,90
8 004779 033667	

GF80043922	
Box (LxWxH) cm	40x24,8x14,5
Pcs	12
Kg	2,90
8 004779 040054	



Medium flow rate watering gun "8 JET"

- Flow rate regulator-modulator with soft non-slip rubber covering
- Front lever with locking device
- Circular "8 JET" selector with ergonomic rubber rim to promote grip and maximise ease of use
- Inspectable micro-perforated disk for possible periodic maintenance requirements
- 20 l/min maximum flow rate at 4 bar



Medium flow rate spray watering gun "8 JET METAL"

- Rugged metal structure with preventive anti-corrosion treatment.
- Flow rate regulator-modulator with soft non-slip rubber covering.
- Front lever with locking device
- Circular "8 JET" selector with ergonomic rubber rim to promote grip and maximise ease of use.
- Inspectable micro-perforated disk for possible periodic maintenance requirements.
- Maximum flow rate 20 l/min at 4 bar.



Multi-jet watering gun

- Simply rotating the front ring allows the user to select 8 different water spray types
- Handle with soft non-slip rubber covering
- Rear adjustment lever to lock the jet.
- Maximum flow rate 10 l/min at 4 bar



GF80006905	
Box (LxWxH) cm	36x21,7x12
Pcs	6
Kg	1,50
8 004779 033711	

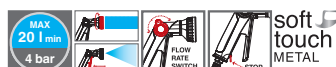

GF80006904	
Box (LxWxH) cm	36x21,7x12
Pcs	6
Kg	2,30
8 004779 033698	



GF80006923	
Box (LxWxH) cm	36x21,7x12
Pcs	8
Kg	2,08
8 004779 040078	

GF80043905	
Box (LxWxH) cm	40x24,8x14,5
Pcs	6
Kg	2,00
8 004779 033728	

GF80043904	
Box (LxWxH) cm	40x24,8x14,5
Pcs	6
Kg	2,25
8 004779 033704	

GF80043923	
Box (LxWxH) cm	40x24,8x14,5
Pcs	10
Kg	2,6
8 004779 040085	

07/ MULTI-JET SPRAY GUNS

Precise and multifunctional equipment, ideal for watering plants and flowers that need a very sweet and gentle jet. The practical selector allows you to easily select the most suitable jet for every need.



“Metal rubber” watering gun

- Rear adjustment lever to lock the jet
- Aluminium tip for adjusting the jet from fine to conical spray
- Maximum flow 12 l/min at 4 bar.



Watering gun Kit

- watering gun
- 3/4" tap connector
- “OPEN” and “ACQUASTOP” hose connectors



GF80006924	
Box (LxWxH) cm 29,7x24,2x11,4	
Pcs 8	
Kg 1,95	8 004779 043376

GF80006925	
Box (LxWxH) cm 37,5x25,5x15,5	
Pcs 6	
Kg 1,50	8 004779 040061

GF80043924	
Box (LxWxH) cm 40x24,8x14	
Pcs 12	
Kg 2,90	8 004779 043413



“Metal rubber” multi-jet watering gun

- Allows the selection of 8 different types of jet by simply rotating the front ring
- Rear lever for adjusting and locking the flow
- Maximum flow 10 l/min at 4 bar.



“8 JET Easy” watering gun Kit

- “8 JET Easy” watering gun
- 3/4" tap connector
- “OPEN” and “ACQUASTOP” hose connectors



GF80006927	
Box (LxWxH) cm 36x21,7x12	
Pcs 8	
Kg 2,08	8 004779 043383

GF80006926	
Box (LxWxH) cm 37,5x25,5x15,5	
Pcs 6	
Kg 1,60	8 004779 040092

GF80043927	
Box (LxWxH) cm 40x24,8x14	
Pcs 10	
Kg 2,60	8 004779 043420



NEW



**“XL Selector”
spray watering gun 5JET**

- Large selector (ø 9cm) with ergonomic rubber
- 5 different spray patterns, including a wide shower spray and an aerator (air-mixed spray), suitable for delicate plants and flowers, even in pots.
- Flow rate regulator-modulator with soft non-slip rubber covering
- Front lever with locking device
- 20 l/min maximum flow rate at 4 bar

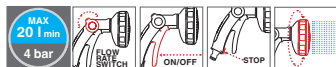

soft touch

GF80006937	
Box (LxWxH) cm 36x21,7x12	
Pcs 4	
Kg 1,12	8 004779 044168

GF80043937	
Box (LxWxH) cm 40x24,8x14	
Pcs 4	
Kg 1,08	8 004779 044175

NEW



**“XL Selector”
spray watering gun 5JET metal-rubber**

- Large selector (ø 9cm) with ergonomic rubber
- 5 different spray patterns, including a wide shower spray and an aerator (air-mixed spray), suitable for delicate plants and flowers, even in pots.
- Flow rate regulator-modulator with soft non-slip rubber covering
- Front lever with locking device
- 20 l/min maximum flow rate at 4 bar
- Corrosion-resistant metal end, and selector back cover

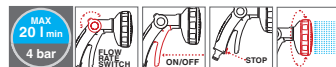

soft touch METAL

GF80006938	
Box (LxWxH) cm 36x21,7x12	
Pcs 4	
Kg 1,40	8 004779 044182

GF80043938	
Box (LxWxH) cm 40x24,8x14	
Pcs 4	
Kg 1,36	8 004779 044199



ABOVE-GROUND IRRIGATION

08/ BORDER SPRAYERS

Accessories suitable for watering of flower pots, edges and flower beds requiring a precise, fine and delicate jet. The comfortable extensions outfit of integrated flow adjustment tap, allow you to easily reach even the less accessible places.



Click-on watering head

Produces a thin gentle jet ideal for delicate flowers.

- Micro-holed disc that can be inspected for internal cleaning
- Maximum flow 30 l/min at 4 bar



Watering wand

Ideal for watering hard-to-reach places such as flower beds, vases and hanging baskets.

- Micro-holed disc that can be inspected for internal cleaning
- Tap for micro-adjustment of flow
- Maximum flow 30 l/min at 4 bar



GF80005430	
Box (LxWxH) cm 29,7x24,2x11,4	
Pcs 10	
Kg 0,67	8 004779 054303

GF80005447	
Box (LxWxH) cm 72x30x7	
Pcs 6	
Kg 1,20	8 004779 003714



GF80043430	
Box (LxWxH) cm 40x12,8x14	
Pcs 25	
Kg 1,04	8 004779 034305

NEW



Border Watering Gun

Produces a thin and gentle jet ideal for delicate flowers

- Micro-holed disc that can be inspected for internal cleaning
- Flow rate regulator-modulator with soft non-slip rubber covering
- Front lever with locking device
- 20 l/min maximum flow rate at 4 bar



Multi-jet watering wand with adjustable head

Ideal for watering hard-to-reach places such as flower beds, vases and hanging baskets.

- 8 different jet types
- Tap for micro-adjustment of flow
- Adjustable joint
- Maximum flow 16 l/min at 4 bar

GF80006928	
Box (LxWxH) cm 36x21,7x12	
Pcs 6	
Kg 1,04	8 004779 043390

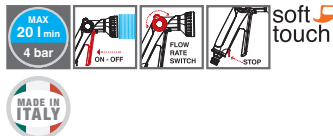

GF80005448	
Box (LxWxH) cm 78,4x14,4x13,4	
Pcs 4	
Kg 1,07	8 004779 009464



GF80043928	
Box (LxWxH) cm 40x24,8x14	
Pcs 6	
Kg 0,98	8 004779 043437

09/ CIRCULAR SPRINKLERS



“CONO” sprinkler

Static sprinkler for small areas and when a very gentle and fine jet is required. Stake version.

- Maximum flow 23 l/min



“ROTAX” sprinkler

Ideal for watering medium-small areas. Stake version.

- Adjustable nozzles to optimise the watering depending on the type of plants
- Maximum flow 19 l/min.



“MINI DRIVER” sprinkler stake version

Multi-purpose circular sprinkler on stake.

- Features stake for easy insertion in the ground.
- Simply rotate the disc to control watering of 4 different areas.
- Maximum flow rate 16 l/min

MAX 23 l/min	2bar min 4bar max		95 m ² r. 5,5 m	MADE IN ITALY
-----------------	----------------------	--	-------------------------------	---------------

GF80005619	
Box (LxWxH) cm 37,5x25,5x15,5	
	Pcs 8
Kg 0,90	

MAX 19 l/min	2bar min 4bar max		154 m ² r. 7 m	MADE IN ITALY
-----------------	----------------------	--	------------------------------	---------------

GF80005633	
Box (LxWxH) cm 37,5x25,5x15,5	
	Pcs 8
Kg 1,00	

MAX 16 l/min	2bar min 4bar max		16 m ² r. 2,5 m	MADE IN ITALY
-----------------	----------------------	--	-------------------------------	---------------

GF80005616	
Box (LxWxH) cm 39x28,5x17,5	
	Pcs 12
Kg 1,60	

MAX 23 l/min	2bar min 4bar max		95 m ² r. 5,5 m	MADE IN ITALY
-----------------	----------------------	--	-------------------------------	---------------

GF80043619	
Box (LxWxH) cm 29,7x24,2x11,4	
	Pcs 8
Kg 0,60	

MAX 19 l/min	2bar min 4bar max		154 m ² r. 7 m	MADE IN ITALY
-----------------	----------------------	--	------------------------------	---------------

GF80043633	
Box (LxWxH) cm 29,7x24,2x11,4	
	Pcs 8
Kg 0,75	

MAX 18 l/min	2bar min 4bar max		100 m ² r. 5,6 m	MADE IN ITALY
-----------------	----------------------	--	--------------------------------	---------------

GF80043616	
Box (LxWxH) cm 37,5x25,5x15,5	
	Pcs 12
Kg 1,29	



“CONO” sprinkler

Static sprinkler for small areas and when a very gentle and fine jet is required.

- Maximum flow 23 l/min



“ROTAX” sprinkler

Ideal for watering medium-small areas.

- Adjustable nozzles to optimise the watering depending on the type of plants
- Maximum flow 19 l/min.



“DRIVER” sprinkler

Multi-purpose circular sprinkler with base.

- Simply rotate the disc to control watering of 8 different areas.
- Maximum flow rate 18 l/min

MAX 23 l/min	2bar min 4bar max		95 m ² r. 5,5 m	MADE IN ITALY
-----------------	----------------------	--	-------------------------------	---------------

GF80005618	
Box (LxWxH) cm 37,5x25,5x15,5	
	Pcs 8
Kg 1,10	

MAX 19 l/min	2bar min 4bar max		154 m ² r. 7 m	MADE IN ITALY
-----------------	----------------------	--	------------------------------	---------------

GF80005632	
Box (LxWxH) cm 37,5x25,5x15,5	
	Pcs 8
Kg 1,30	



MAX 18 l/min	2bar min 4bar max		100 m ² r. 5,6 m	MADE IN ITALY
-----------------	----------------------	--	--------------------------------	---------------

GF80005617	
Box (LxWxH) cm 37,5x25,5x15,5	
	Pcs 4
Kg 1,30	

MAX 23 l/min	2bar min 4bar max		95 m ² r. 5,5 m	MADE IN ITALY
-----------------	----------------------	--	-------------------------------	---------------

GF80043618	
Box (LxWxH) cm 37,5x25,5x15,5	
	Pcs 8
Kg 0,95	

MAX 19 l/min	2bar min 4bar max		154 m ² r. 7 m	MADE IN ITALY
-----------------	----------------------	--	------------------------------	---------------

GF80043632	
Box (LxWxH) cm 37x24x19,5	
	Pcs 8
Kg 1,10	

MAX 18 l/min	2bar min 4bar max		100 m ² r. 5,6 m	MADE IN ITALY
-----------------	----------------------	--	--------------------------------	---------------

GF80043617	
Box (LxWxH) cm 37,5x25,5x15,5	
	Pcs 4
Kg 1,19	

"4 JET LIFT" sprinkler

Professional rotating sector sprinkler with turbine movement suitable for watering any surface even very large areas. Stake version.

- 4 different jet types
- Adjustable head for varying the watering area
- Watering angle from 15° to 360°
- Maximum flow 15 l/min



GF80005670	
Box (LxWxH) cm 37,5x25,5x15,5	
Pcs 6	
Kg 1,60	
8 004779 023156	

GF80043670	
Box (LxWxH) cm 37,5x25,5x15,5	
Pcs 12	
Kg 2,70	
8 004779 023163	

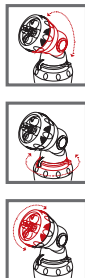

"4 JET LIFT" sprinkler

Professional rotating sector sprinkler with turbine movement suitable for watering any surface even very large areas.

- 4 different jet types
- Adjustable head for varying the watering area
- Watering angle from 15° to 360°
- Weighted base of remarkable stability
- Maximum flow 15 l/min



GF80005667	
Box (LxWxH) cm 39x28,5x27	
Pcs 6	
Kg 3,98	
8 004779 012594	



"SUPER ROTAX" rotating sprinkler

With two rotating arms with twin adjustment, for uniform watering of large and medium areas.

- Nozzles and arms separately adjustable
- Watering area from 30 to 160 sqm.
- Base of remarkable stability
- Maximum flow 15 l/min



GF80005615	
Box (LxWxH) cm 39x28,5x27	
Pcs 6	
Kg 2,38	
8 004779 056154	

10/ OSCILLATING SPRINKLERS



“ASTRAL 4” oscillator

Oscillating sprinkler with continuously variable watering arc from 20° to 100°. Very quiet, it provides various watering possibilities, ideal for uniformly covering either small or large rectangular areas.

- plastic oscillating arm with 16 nozzles
- pin for cleaning the holes
- maximum flow 15 l/min

MAX 15 l/min	2bar min 4bar max	20-100°	180 m ² 12 x 15 m	MADE IN ITALY
GF80005669				
Box (LxWxH) cm 40x28x21				
	Pcs 6			
Kg 2,52	8 004779 023071			



11/ PULSATING SPRINKLERS

“SPIT 3” pulsating sprinkler

Sectional pulsating sprinkler, ideal for large areas.

- Jet interruption device for uniform distribution of water
- Watering angle from 15° to 360°
- Tripod in weighted aluminium
- Maximum flow 15 l/min



MAX 15 l/min	2bar min 4bar max			15-360°	450 m ² r. 12 m	MADE IN ITALY
GF80005630						
Box (LxWxH) cm 40,4x40,5x16,5						
	Pcs 6					
Kg 6,23	8 004779 056307					



“SPIT 2” pulsating sprinkler

Sectional pulsating sprinkler, ideal for large areas.

- Jet interruption device for uniform distribution of water
- Watering angle from 15° to 360°
- Weighted base of remarkable stability
- Maximum flow 15 l/min

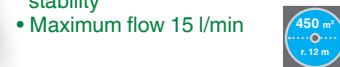

MAX 15 l/min	2bar min 4bar max			15-360°	450 m ² r. 12 m
GF80005627					
Box (LxWxH) cm 39x28,5x27					
	Pcs 6				
Kg 3,83	8 004779 056277				



“COMET” oscillator

Oscillating sprinkler with continuously variable watering arc from 20° to 100°. Very quiet, it provides various watering possibilities, ideal for uniformly covering either small or large rectangular areas.

- Oscillating arm in metal with 16 nozzles
- Pin for cleaning the holes
- Maximum flow 16 l/min



GF80005666	
Box (LxWxH) cm 40x28x21	
Pcs 6	
Kg 2,20	8 004779 012570



“SIDERAL” oscillator

Oscillating sprinkler with continuously variable watering arc from 20° to 100°. Very quiet, it provides various watering possibilities, ideal for uniformly covering either small or large rectangular areas.

- Oscillating arm in metal with 18 brass nozzles.
- Solid weighted base to prevent overturning.
- Pin for cleaning the holes
- Maximum flow 18 l/min



GF80005662	
Box (LxWxH) cm 59x39,5x17	
Pcs 6	
Kg 3,90	8 004779 056628

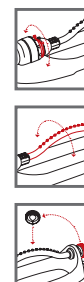
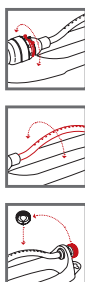

“SPIT 1” pulsating sprinkler

Sectional pulsating sprinkler, ideal for large areas. Stake version.

- Jet interruption device for uniform distribution of water
- Watering angle from 15° to 360°
- Maximum flow 15 l/min



“SPIT METAL” pulsating sprinkler

Sector pulsating metal sprinkler assembled on tip, ideal also for large surfaces.

- Jet interruption device for uniform distribution of water
- Watering angle from 15° to 360°
- Maximum flow 16 l/min



“SPIT” pulsating sprinkler head

Spare sector pulsating sprinkler head in plastic.

- Jet interruption device for uniform distribution of water
- Watering angle from 15° to 360°
- Maximum flow 15 l/min



“SPIT METAL” pulsating sprinkler head

Spare sector pulsating sprinkler head in metal.

- Jet interruption device for uniform distribution of water
- Watering angle from 15° to 360°
- Maximum flow 16 l/min



GF80005624	
Box (LxWxH) cm 37,5x25,5x15,5	
Pcs 8	
Kg 1,20	8 004779 023132



GF80002621	
Box (LxWxH) cm 37x14x13	
Pcs 4	
Kg 1,66	8 004779 026218



GF80007205	
Box (LxWxH) cm 18x15,5x21	
Pcs 12	
Kg 0,91	



GF80007206	
Box (LxWxH) cm 18x15,5x21	
Pcs 12	
Kg 3,20	

GF80043624	
Box (LxWxH) cm 37,5x25,5x15,5	
Pcs 12	
Kg 1,40	8 004779 023149

ABOVE-GROUND IRRIGATION

12/ AQUABAG

For small gardens, terraces or balconies, the practical and compact hose reel has a neat size and is easy to use and store. For watering plants and flowers or cleaning surfaces of all kinds, ideal in any context.

aquabag MAXI

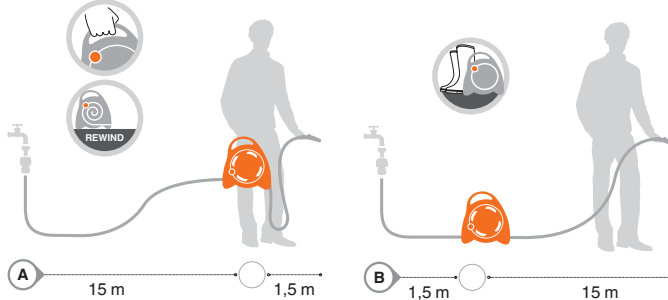

16,5m

"AQUABAG MAXI" Portable hose-reel

Designed for any application that requires a compact product, it is ideal for balconies, terraces, medium-sized gardens. Manually rewinding, portable, easy to store.

- 16,5 m of braided flexible hose
- 2 quick e lick hose connectors
- 3/4" tap connector
- 8 jet ergonomic nozzle

GF80005608	
Box (LxWxH) cm 42x36x35	
	Pcs 2
Kg 7,00	



Palbox 18 pcs AQUABAG display

Self-supporting cardboard display with crowner. It is supplied assembled and completed with products.

It contains: 18 pcs AquaBag
Opened dimensions:
cm 72 x 54 x 140 h

aquabag

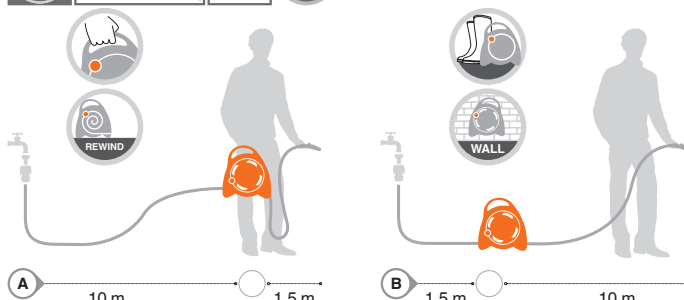

11,5m

"AQUABAG" Mini hose reel

The new mini version hose reel is ideal for watering plants, flowers and pots on patios, balconies, verandas and small gardens. Thanks to its dual purpose design — floor standing or portable — this is a product that proves highly practical when in use, by virtue of being compact and lightweight, and with its new attractive styling, makes leisure time in the open air even more enjoyable.

- 11,5 meters of braided flexible hose (10 m rewinding inside + 1,5 m outside)
- 2 hose connectors
- "3 JET" variable flow-rate ergonomic nozzle
- "indoor-outdoor" 3/4" adaptor, ideal for any type of tap, also for those used indoors (for example: kitchen, bathroom, laundry...)

Product displays are in the merchandising section.

GF80176077	
Box (LxWxH) cm 72x54x102,5	
	Pcs 18
Kg 44,10	EAN 8004779019289

GF80005606	
Box (LxWxH) cm 39x29x32	
	Pcs 2
Kg 4,50	

ABOVE-GROUND IRRIGATION

13/ HOSE REELS

Practical to use and with an attractive design, these hose reels, available in portable trolley versions, are suitable for gardens of all sizes. Also available in the Ready version, pre-assembled and fitted with accessories, ready to go.

MINI CONCEPT



“MINI CONCEPT” portable

- Capacity 20 m of 1/2" hosepipe
- Complete with click connectors

MINI CONCEPT PLUS



“MINI CONCEPT PLUS” portable kit

- Adjustable spray nozzle
- Click-fit “Aquastop” connector
- 15 m of 1/2" hosepipe



“REELY” portable

- Complete with hose connectors
- Capacity 40 m of 1/2" hosepipe

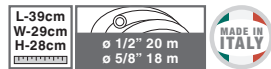

GF80005838	
Box (LxWxH) cm 29x15,5x29	
Pcs 1	
Kg 1,00	8 004779 030079

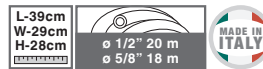

GF80005846	
Box (LxWxH) cm 29x26x29	
Pcs 1	
Kg 2,60	8 004779 030086



GF80005740	
Box (LxWxH) cm 39x14,5x37	
Pcs 1	
Kg 1,76	8 004779 009440



“EUROTANK” trolley

- Capacity 60 m of 1/2" hosepipe
- Supplied complete with hose connectors



“EUROTANK PLUS” trolley

- 20 m of 1/2" wired hosepipe
- 3/4" Tap connector
- 4 Hose connectors for 1/2"-5/8"
- Adjustable spray nozzle



“Tank 2” trolley

- Capacity 70 m of 1/2" hosepipe
- Supplied complete with hose connectors



“IDEA” trolley

- Plastic and metal hose reel trolley, practical and sturdy, guaranteeing optimum performance. With its retractable telescopic handle, the trolley is truly compact and easily stored, even in tight spaces. Perfect for users seeking a complete and versatile watering solution.
- With wheels and retractable telescopic handle
 - SOFT TOUCH non-slip handle
 - Capacity max 60 m of 1/2" hose

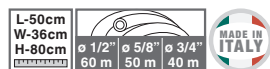

GF80005729	
Box (LxWxH) cm 39x14,5x37	
Pcs 1	
Kg 2,48	8 004779 005305

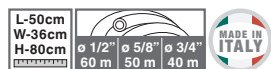

GF80005756	
Box (LxWxH) cm 39x23,5x39	
Pcs 1	
Kg 4,23	8 004779 005558

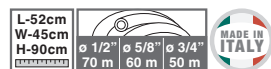

GF80005744	
Box (LxWxH) cm 40x16x40	
Pcs 1	
Kg 2,88	8 004779 016752



GF80005788	
Box (LxWxH) cm 38,5x14,5x56	
Pcs 1	
Kg 2,40	8 004779 018893



“REELY PLUS” portable kit

- 20 m of 1/2" wired hosepipe
- 3/4" Tap connector
- 4 Hose connectors for 1/2"-5/8"
- Adjustable spray nozzle



GF80005817	
Box (LxWxH) cm 39x23,5x39	
Pcs 1	
Kg 3,61	8 004779 026171



Trolley/tap connecting kit

- Composed of:
- 1,5 m of wired 1/2" hosepipe
 - 2 click-fit 1/2" hose connectors
 - 3/4" tap connector



GF80007200	
Box (LxWxH) cm 29,7x25,7x25,4	
Pcs 6	
Kg 2,54	8 004779 072000

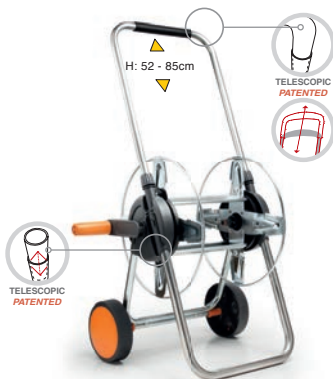

“IDEA PREMIUM” metal trolley

- Steel discs and drum with anticorrosion treatment
- Retractable telescopic handle
- Soft touch non-slip handle
- 2 SOFT TOUCH “quick-click” hose connectors
- Maximum capacity 60 m of ϕ 1/2" hose
- Extremely sturdy

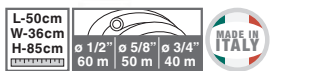

GF80005787	
Box (LxWxH) cm 38,5x14,5x55	
Pcs 1	
Kg 3,40	8 004779 018886

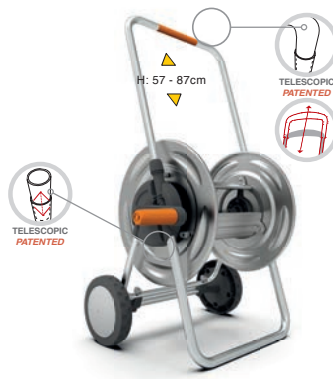

“METAL TANK 75” metal trolley

- Sturdy and stable aluminum frame
- Steel drum with corrosion-resistant coating
- Retractable telescopic handle
- 2 SOFT TOUCH “quick-click” hose connectors
- Maximum capacity: 75 m $\frac{1}{2}$ " hose



GF80005829	
Box (LxWxH) cm 55x22x45	
Pcs 1	
Kg 7,00	8 004779 029776



14/ "READY" HOSE REELS



"MINI CONCEPT READY 15" portable kit

Assembled and equipped with 15 m hose, connectors and spray nozzle. Supplied in 120 x 80 cm pallet trays with 12 units per tray stackable up to 4 levels (H125 cm).



"CONCEPT READY" trolley kit

Portable hose reel trolley in plastic and metal fully assembled and equipped, supplied with pallet trays measuring 120 x 80cm with 6 units per tray, stackable up to 4 levels, (H 240cm).

- trolley with wheels and telescopic handle
- medium size adjustable nozzle (12 - 15mm)
- 4 x automatic couplings \varnothing 1/2"-5/8" (20 - 27mm)
- 25m hose \varnothing 1/2"

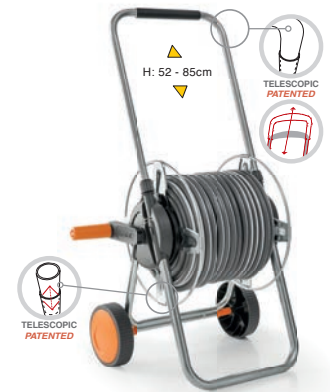

Kit "IDEA PREMIUM READY"

Hose reel trolley in metal mounted on wheel. Supplied fully assembled and equipped, on palletised trays of 120x80 cm carrying 6 units per pallet, stackable 4-high (height 240 cm).

- Trolley with wheels and telescopic retractable handle with SOFT TOUCH non-slip handle, max capacity 60 m of 1/2" hose
- steel discs and drum with anticorrosion treatment
- "3 JET" ergonomic nozzle with flow-rate regulator-modulator
- 4 SOFT TOUCH automatic connectors and 3/4 tap adaptor
- 25 m of 1/2 hose
- extremely sturdy

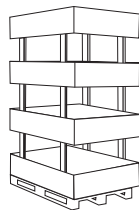

supplied in 120 x 80 cm pallet trays with 12 units per tray stackable up to 4 levels (H 125 cm).

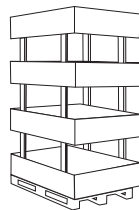

supplied in 120 x 80 cm pallet trays with 6 units per tray stackable up to 4 levels (H 240 cm).



supplied in 120 x 80 cm pallet trays with 6 units per tray stackable up to 4 levels (H 240 cm).



GF80005793	
Box (LxWxH) cm 80x120x128	
Pcs 48	
Kg 135	8 004779 014093



GF80005749	
Box (LxWxH) cm 80x120x240	
Pcs 24	
Kg 110	8 004779 015670



GF80005789	
Box (LxWxH) cm 85x122x242	
Pcs 24	
Kg 168	8 004779 018909



15/ HOSEPIPES

High quality, reliable hosepipes. Different sizes and lengths for every kind of garden. Flexible and manageable for pleasant, safe use.

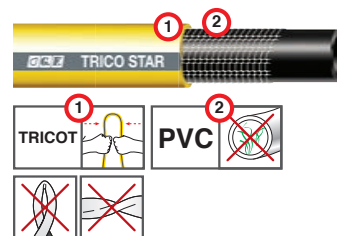

Trico Star hose

- Substrate in anti-algae PVC
- Reinforced with knitted polyester
- High quality opaque covering

Ø 1/2"	CONDITIONS OF USE	
	working 8 bar	burst 24 bar

GF80007011		
Box (LxWxH) cm ø 29x8		
15m	Pcs 1	8 004779 070112
Kg 1,80		

Ø 3/4"	CONDITIONS OF USE	
	working 7 bar	burst 21 bar

GF80007016		
Box (LxWxH) cm ø 40x12		
25m	Pcs 1	8 004779 070167
Kg 5,83		

Ø 5/8"	CONDITIONS OF USE	
	working 8 bar	burst 24 bar

GF80007013		
Box (LxWxH) cm ø 33x9		
15m	Pcs 1	8 004779 070136
Kg 2,50		

GF80007014		
Box (LxWxH) cm ø 41x8		
25m	Pcs 1	8 004779 070143
Kg 3,94		

GF80007012		
Box (LxWxH) cm ø 30x13		
25m	Pcs 1	8 004779 070129
Kg 2,95		

GF80007017		
Box (LxWxH) cm ø 41x22		
50m	Pcs 1	8 004779 070174
Kg 11,45		

GF80007015		
Box (LxWxH) cm ø 41x16		
50m	Pcs 1	8 004779 070150
Kg 8,03		



"Tricokit" roll kit

- 25 m of 1/2" Trico Star hosepipe
- Adjustable spray nozzle
- 3/4" tap connector
- "Open" and "acquastop" hose connectors of 1/2"-5/8"



"Betakit" roll kit

- 25 m of 1/2" Beta hosepipe
- Adjustable spray nozzle
- 3/4" tap connector
- "Open" and "acquastop" hose connectors of 1/2"-5/8"



"Alphakit" roll kit

- Roll of 1/2" Alpha hose pipe
- Adjustable spray nozzle
- 3/4" tap connector
- "Open" and "acquastop" hose connectors of 1/2"-5/8"

Ø 1/2"

GF80007027		
Box (LxWxH) cm ø 30x14		
25m	Pcs 1	8 004779 070273
Kg 3,45		

Ø 1/2"

GF80007088		
Box (LxWxH) cm ø 27x13		
25m	Pcs 1	8 004779 010484
Kg 2,61		

Ø 1/2"

GF80007028		
Box (LxWxH) cm ø 27x8		
15m	Pcs 1	8 004779 070280
Kg 1,38		

GF80007029		
Box (LxWxH) cm ø 27x17		
25m	Pcs 1	8 004779 070297
Kg 2,36		



Beta hose

Braided hosepipe in three layers with interposed reinforcing braid in high-strength polyester.

- Anti-algae substrate
- Covering in silver PVC

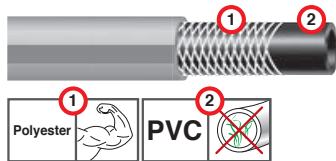

Ø 5/8"	CONDITIONS OF USE	
	working	burst
	9 bar	27 bar

GF80007083		
Box (LxWxH) cm ø 34x8		
15m	Pcs 1	
Kg 1,98		8 004779 010439

GF80007084		
Box (LxWxH) cm ø 37x9		
25m	Pcs 1	
Kg 3,17		8 004779 010446

GF80007085		
Box (LxWxH) cm ø 36x19		
50m	Pcs 1	
Kg 6,30		8 004779 010453



Alpha hose

Braided hosepipe in three layers interposed with a reinforcing gauze in polyester.

- Polyester reinforcing net
- Anti-algae black substrate
- Transparent green covering

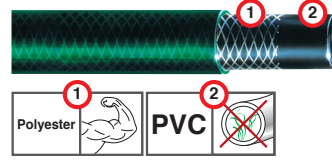

Ø 5/8"	CONDITIONS OF USE	
	working	burst
	7 bar	21 bar

GF80007094		
Box (LxWxH) cm ø 34x8		
15m	Pcs 1	
Kg 1,71		8 004779 070945

GF80007095		
Box (LxWxH) cm ø 38x9		
25m	Pcs 1	
Kg 2,89		8 004779 070952

GF80007096		
Box (LxWxH) cm ø 36x20		
50m	Pcs 1	
Kg 6,67		8 004779 070969

Ø 1/2"	CONDITIONS OF USE	
	working	burst
	10 bar	30 bar

GF80007081		
Box (LxWxH) cm ø 27x7		
15m	Pcs 1	
Kg 1,47		8 004779 010415

GF80007082		
Box (LxWxH) cm ø 28x12		
25m	Pcs 1	
Kg 2,55		8 004779 010422

Ø 3/4"	CONDITIONS OF USE	
	working	burst
	8 bar	24 bar

GF80007086		
Box (LxWxH) cm ø 36x15		
25m	Pcs 1	
Kg 5,00		8 004779 010460

GF80007087		
Box (LxWxH) cm ø 40x20		
50m	Pcs 1	
Kg 9,33		8 004779 010477

Ø 1/2"	CONDITIONS OF USE	
	working	burst
	8 bar	24 bar

GF80007091		
Box (LxWxH) cm ø 27x8		
15m	Pcs 1	
Kg 1,42		8 004779 070914

GF80007092		
Box (LxWxH) cm ø 30x10		
25m	Pcs 1	
Kg 2,34		8 004779 070921

Ø 3/4"	CONDITIONS OF USE	
	working	burst
	7 bar	21 bar

GF80007097		
Box (LxWxH) cm ø 37x17		
25m	Pcs 1	
Kg 5,16		8 004779 070976

GF80007098		
Box (LxWxH) cm ø 43x22		
50m	Pcs 1	
Kg 8,74		8 004779 070983



Wall-mounting metal hose support.

For fixing to the wall to support the roll of hosepipe. Including wall fixing kit.



GF80005844		
Box (LxWxH) cm 40x28x20,5		
	Pcs 8	
Kg 3,84		8 004779 030659



Wall hosepipe holder

For fixing to the wall to support the roll of hosepipe.



GF80007040		
Box (LxWxH) cm 38,5x29x30		
	Pcs 8	
Kg 2,40		8 004779 070402

16/ SPECIAL HOSES



10 m Spiral Hosepipe Kit Plus

- 10 m of extendable spiral hosepipe
- Tap connector for 1/2"-3/4"
- SOFT TOUCH "open" hose connectors
- "8 Jet Easy Plus" spray gun
- Adaptor ring for kitchen and bathroom taps
- Wall-mounting brackets



10 m Spiral Hosepipe Kit

- 10 m of extendable spiral hosepipe
- 3/4" tap connector
- "open" hose connectors
- Adjustable spray nozzle



Micro-pierced tubing

Tubing sprinkler with three channels for fine spray watering

- 15 m hosepipe (GF80007032)
- 7,5 m hosepipe (GF80007031)



25 cm

Included Included MADE IN ITALY

68 m²

34 m²



KIT READY MAX 10m

1x WALL 1x 1x 2x 1x

ø 1/2" 15 x 21 mm ø 3/4" 20 x 27 mm ø 3/4" GAS universal MADE IN ITALY ø 3/4" 20 x 27 mm

KIT READY MAX 10m

1x 2x 1x

ø 3/4" 20 x 27 mm

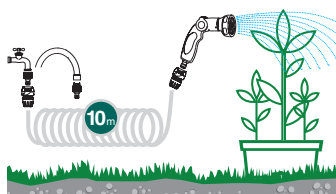

GF80007233	
Box (LxWxH) cm 42x38x36,5	
Pcs 4	
Kg 5,50	8 004779 021626

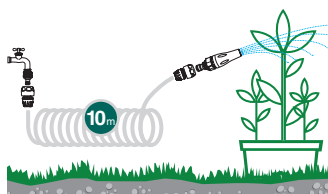

GF80007204	
Box (LxWxH) cm 50x10,5x10,5	
Pcs 1	
Kg 0,92	8 004779 072048

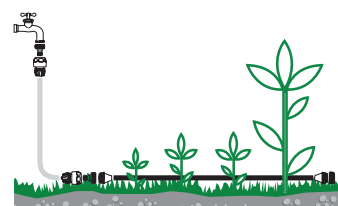

GF80007032	
Box (LxWxH) cm ø 36x3	
15m Pcs 1	
Kg 1,32	8 004779 070327

GF80007031	
Box (LxWxH) cm ø 29x3	
7,5m Pcs 1	
Kg 0,72	8 004779 070310



1/2" diam. porous hose pipe

Ideal for localised watering of groups of plants, hedges, flowerbeds, vegetable gardens and orchards.

The slow and continuous release manages to save up to 50% of water perfectly maintaining damp soil and avoiding excessive evaporation.

- 15 meters
- Complete with end of line cap
- Male connection
- Maximum pressure in use of 2 bar

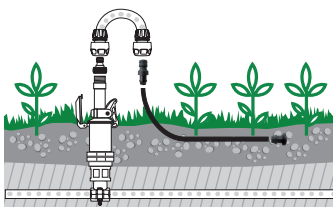
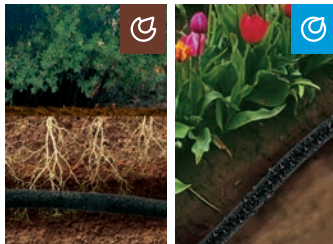
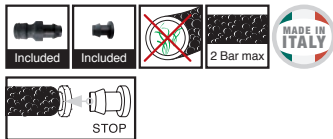

GF80002300		
Box (LxWxH) cm \varnothing 30x10		
15m	Pcs 1	
Kg 1,36		



"AQUAPOP JOY"

Self-extendable hose kit for watering plants and flowers and washing outdoor surfaces. Ideal for small gardens, terraces or balconies. Practical, lightweight and easy to use, thanks to the hose that expands up to 15 m with water pressure. After use, the emptied hose retracts becoming very compact.

- self-extendable hose of various lengths: up to 7,5m / 15m / 22,5m
- mini nozzle
- click-fit hose connectors
- 3/4" tap connector



GF80007452		
Box (LxWxH) cm 39X37X20		
7,5m	Pcs 10	
Kg 3,2		

GF80007453		
Box (LxWxH) cm 44X36X29		
15m	Pcs 10	
Kg 6,2		

GF80007454		
Box (LxWxH) cm 49X42X28		
22,5m	Pcs 10	
Kg 8,7		

17/ AQUAFLO SMART 16

- **INDEPENDENT:** works without batteries, electricity or connection to the tap.
- **INDOOR AND OUTDOOR:** can be used safely both inside and outside the house
- **ADJUSTABLE:** to water up to 16 average-sized plant pots for 14/18 days
- **SIMPLE AND SAFE:** the appropriate amount of water is supplied through an automatic dispenser, sufficient to maintain correct dampness in the soil. Equipped with an 18-litre tank, it can deliver 1 to 2 litres of water a day at precise and regular intervals. Fitted with scale prevention device. Easy to use and, convenient.



Watering system for apartments

An autonomous device and very simple for watering up to 16 medium-sized apartment vases for 14/18 days. Thanks to an automatic doser, the right amount of water is dispensed, sufficient to maintain correct dampness in the soil.

- 18 l water tank
- Dispenses from 1 to 2 l of water a day
- CONTAINS:
1 automatic dispensing doser
1 tank of 18 l
30 m of capillary hose in PVC
16 tube supports
20 plugs
Instruction manual

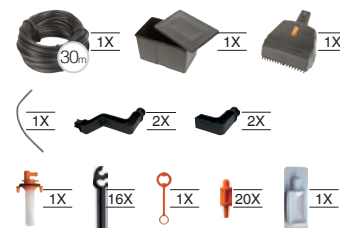

WORKS:

- WITHOUT ELECTRICITY
- WITHOUT BATTERIES
- WITHOUT CONNECTION TO A TAP

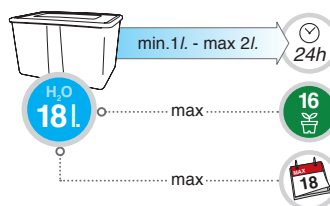
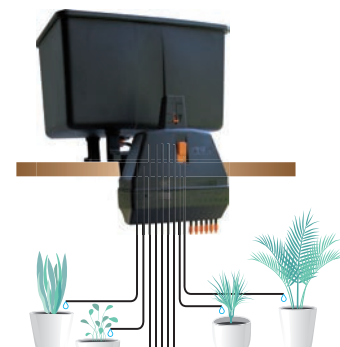

GF80006300	
Box (LxWxH) cm 39x25,5x25,5	
Pcs 1	
Kg 2,99	8 004779 063008

18/ PROGRAMMERS

Electronic programmers allow watering to be set for more efficient care of plants and flowers.



“AQUATIME EASYDROP” electronic programmer

Simple, reliable and with a modern design, it allows setting different programs using the convenient selector knob. Set the knob on START to begin irrigation and on STOP to interrupt irrigation. The irrigation cycle is stored and automatically repeated every 24 hours. It's therefore possible to configure several combinations.

- Set the knob to MAN for manual starts outside of programming cycles
- Powered by 9 Volt alkaline battery
- Water flow stop device in case of dead battery
- Electrical components protected from water and moisture
- 3/4" tap connection
- Maximum operating pressure 8 bar



“AQUATIME DUE.5” electronic programmer

Simple, intuitive and practical, with a modern design, it has programs that can be combined to create up to 25 + 1 possibilities, manageable through the two easy-to-use selectors knobs.

- starts every 6, 12, 24, 48, 72 hours for 1, 3, 5, 20, 45 minutes
- manual start button for starting independently of the programme cycle
- button for delayed start 1 to 8 hours after initial setting depending on user needs
- Easy Balcony function: ideal for drip irrigation
- powered by 9 Volt alkaline battery
- Water flow stop device in case of dead battery
- electrical components protected from water and moisture
- 3/4" tap connection
- Maximum operating pressure 8 bar



“GF10” electronic programmer

Simplicity, reliability, and modern design allow you to program different programs (10) through the practical button selector.

To adjust the frequency and duration of watering, turn the button to the desired value. Watering will begin 3 seconds after the last rotation.

- Set the selector to MAN for manual starts outside of programmed cycles.
- Operates with a 9-volt alkaline battery.
- Water supply cut-off device in case of low battery.
- Electrical components protected against water and moisture.
- 3/4" tap connection.
- Maximum operating pressure: 8 bars.

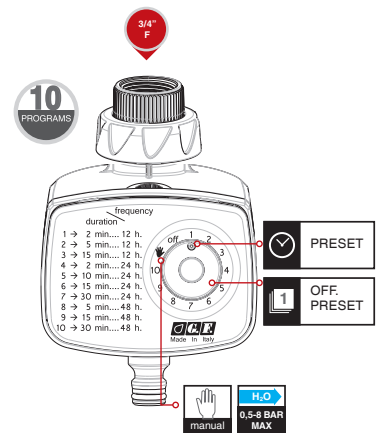
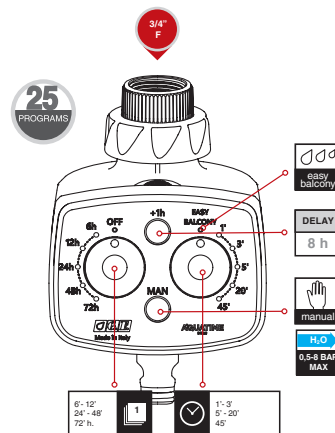
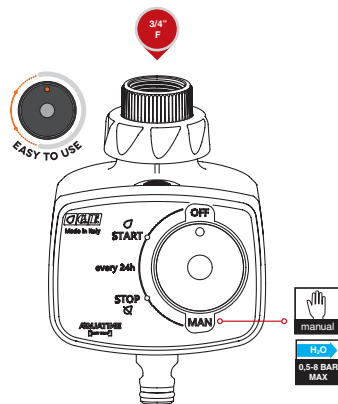

GF80006026	
Box (LxWxH) cm 18,5x22,5x14,5	
Pcs 2	
Kg 1,08	8 004779 036590



GF80006025	
Box (LxWxH) cm 18,5x22,5x14,5	
Pcs 2	
Kg 1,08	8 004779 036675



GF80006018	
Box (LxWxH) cm 18,5x22,5x14,5	
Pcs 2	
Kg 1,08	8 004779 029783



“GF16 easy” electronic programmer

Simple and reliable, it features programs that can be combined with each other up to 16 + 1 combinations, selectable through a handy knob selector. Starts every 6, 12, 24, 48 hours with prefixed watering times. “Easy garden” program for the optimization of the watering cycles: two preset daily watering to water properly morning and evening, improving the absorption of water by the soil, thus avoiding the plants damaging.

- manual start button for starting independently of the programme cycle
- works with 9 volt alkaline battery
- device to stop the water flow in case the battery runs down
- electrical components protected from water and humidity
- 3/4” attachment to tap
- maximum pressure in use 8 Bar

“GF48” electronic programmer

It is simple, easy to understand and practical to be used, provides combinations of programs up to 48 possibilities managed through the easy to use concentric knob switches. Starts every 3, 6, 12, 24, 48, 96 hours for 1, 2, 5, 10, 15, 30, 60, 120 minutes.

- manual start button for starting independently of the program cycle
- button for delaying of 8 hours after the initial setting-up
- works with 9 volt alkaline battery
- device to stop the water flow in case the battery runs down
- electrical components protected from water and humidity
- 3/4” attachment to tap
- maximum pressure in use 8 Bar

Bluetooth® GFPRO Eco Watering Computer irrigation programmer

GFPRO Eco Watering Computer irrigation programmer controlled via **GF App** to manage home-gardening irrigation directly from your smartphone. Easy to use, it allows irrigation programming by connecting the device to the programmer via **Bluetooth® wireless technology**. Through the control panel of the **GF App** it is possible to:

- **Set up customized programs:** setting irrigation start time, duration and frequency for a maximum of 4 daily irrigations.
- **Set up predefined programs:** designed for irrigation at the optimal time of the day and differentiated between surface irrigation and Micro/Drip irrigation.
- **Set up the ECO function:** it adjusts the duration of the

programs previously set according to the current season, thus avoiding water waste for a more ecological choice.

- **Manually adjust the programmed watering duration:** it is possible to increase or decrease the duration of the programs previously set based on warmer or rainier weather forecasts for the next 3 days.
- **Manually open or close the water flow.**
- **Combine the app and simultaneously manage multiple GFPRO Eco Watering Computer programmers.**

App available for iOS and Android devices.

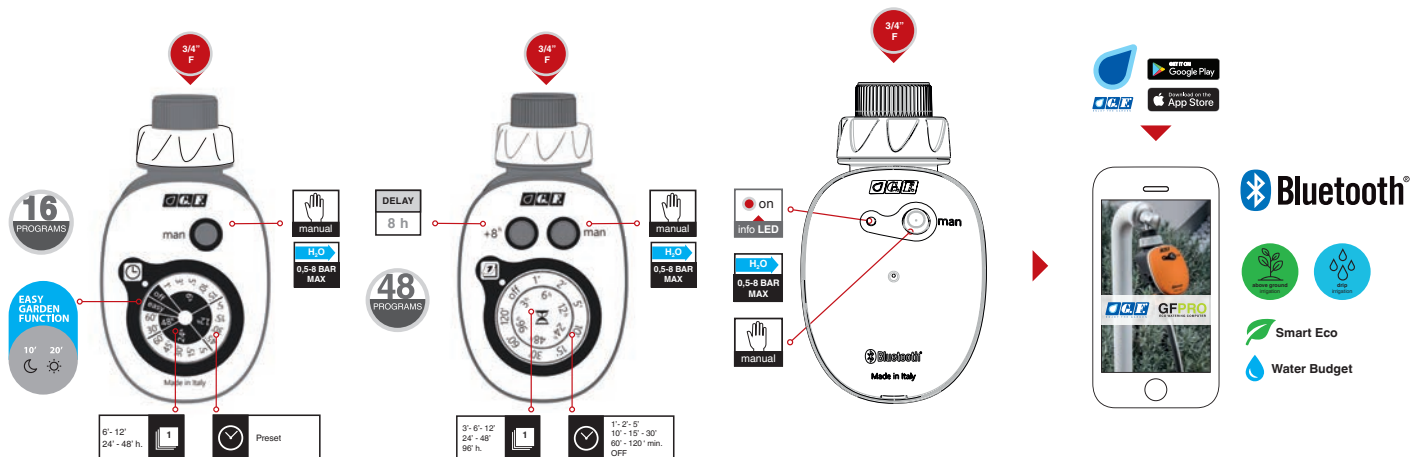

GF80006016	
Box (LxWxH) cm 18x19x12	
Pcs 2	
Kg 1,00	8 004779 022944



GF80006015	
Box (LxWxH) cm 18x19x12	
Pcs 2	
Kg 1,00	8 004779 022937



GF80006017	
Box (LxWxH) cm 18x19x12	
Pcs 2	
Kg 0,90	8 004779 029660



Watering Computer Kit 20 pots/zones AQUATIME Solar UNO.3

Kit Ready Solar-Powered Irrigation Timer:

- **AUTONOMOUS:** Thanks to the integrated solar panel (~3500 mm²) and pump system, it does not require an electrical outlet or connection to the water supply.
- **ECO-FRIENDLY:** Powered by solar energy, even on cloudy days thanks to rechargeable batteries, requiring 1.2V AA NiMH (HR6) batteries with a minimum capacity of 2000 mAh (not included in the kit).
- **SIMPLE and SAFE:** Just place the intake system in a container filled with water and select one of the 13 preset programs by turning the dial (to activate manual starts out of the programming cycles, set the dial to MAN). Additionally, the electronic components are protected from water and humidity.
- **PRACTICAL:** Thanks to the hook on the back, you can hang the timer on the wall or, by folding the support, place it directly on a flat surface.
- **KIT READY:** The kit contains everything needed for drip irrigation up to 20 zones/pots.

- 1 irrigation timer
- 1 filter integrated into the intake system
- 1 air release valve
- 20m of 4x6 capillary hose
- 20 self-compensating drippers (2 l/h)
- 2 straight connectors
- 2 elbow connectors
- 20 T-connectors
- 4 end plugs

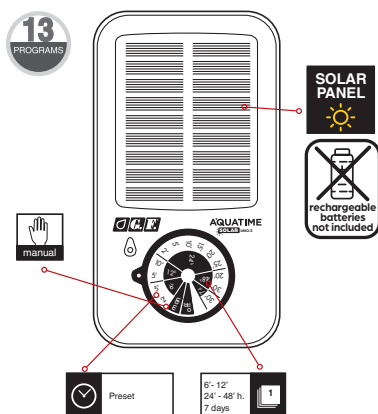
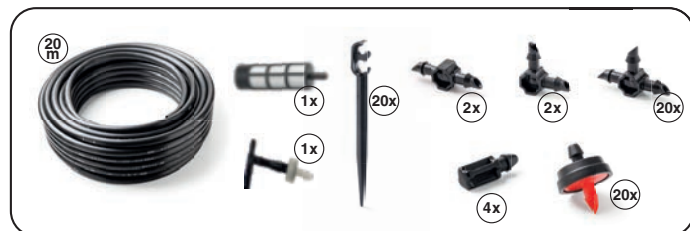
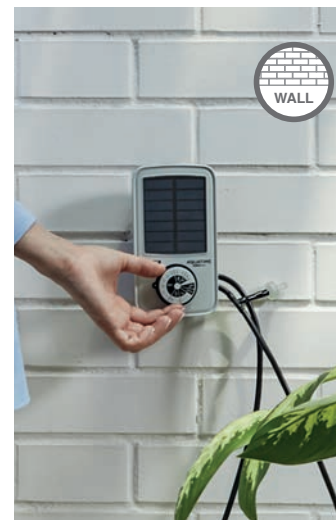

GF80006165	
Box (LxWxH) cm 31x18x23	
Pcs 2	
Kg 2,20	
8 004779 044021	

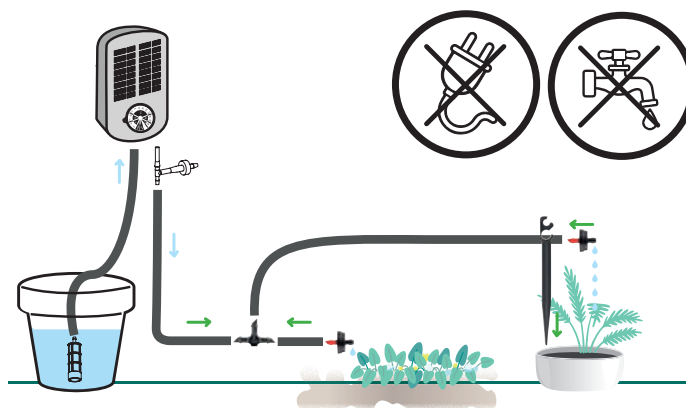

**19/
DRIPPERS**



blister
10x

“Barrel” adjustable dripper

The axial adjustment of the two bodies allows accurate adjustment of the flow. Adjustable from 0 to 8 l./hr. at the advised pressure of 1.5 bar. In-line dripper.

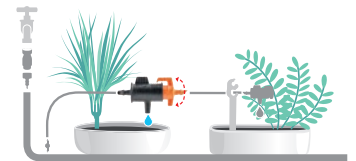

GF80006208	
Box (LxWxH) cm	22,7x15,2x15,4
Pcs 10	
Kg 0,71	



blister
10x



blister
10x



blister
10x



blister
10x

“Barrel” adjustable dripper

The axial adjustment of the two bodies allows accurate adjustment of the flow. Adjustable from 0 to 8 l./hr. at the advised pressure of 1.5 bar. End of line dripper.

“Autocompensating” drippers

Dispense at a constant flow-rate independently of the supply pressure. Excellent for standardising the flow at the beginning and end of the line. 2 l/h dripper.

“Autocompensating” drippers

Dispense at a constant flow-rate independently of the supply pressure. Excellent for standardising the flow at the beginning and end of the line. 4 l/h dripper.

“Ottima 360°” adjustable dripper

The click rotation of the head allows simultaneous adjustment of flowrate and diameter of watering. Adjustable from 0 to 60 l./hr. Advised pressure to use, 1,5 bar.

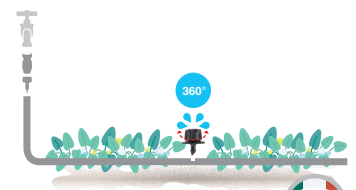
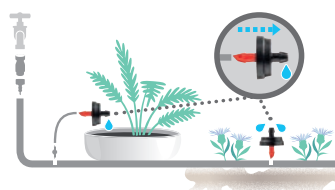
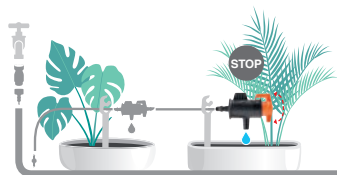

GF80006200	
Box (LxWxH) cm	22,7x15,2x15,4
Pcs 10	
Kg 0,70	



GF80006227	
Box (LxWxH) cm	20,7x14,7x10,4
Pcs 10	
Kg 0,39	



GF80006224	
Box (LxWxH) cm	20,7x14,7x10,4
Pcs 10	
Kg 0,39	



GF80006239	
Box (LxWxH) cm	20,7x14,7x10,4
Pcs 10	
Kg 0,35	



blister
10x

“Delta drip” adjustable dripper

The rotation of the key adjusts the flow until totally closed. Adjustable from 0 to 6 l./hr. at the advised pressure of 1,5 bar.



blister
10x

“Delta drip” adjustable dripper

The rotation of the key adjusts the flow until totally closed. Adjustable from 0 to 6 l./hr. at the advised pressure of 1,5 bar. Version complete with stake and direct connection to the hose.



blister
10x

“Ottima 180” adjustable dripper

The click rotation of the head allows simultaneous adjustment of flowrate and diameter of watering. Adjustable from 0 to 60 l./hr. Advised pressure to use, 1,5 bar.



blister
10x

“Ottima 360” adjustable dripper

The click rotation of the head allows simultaneous adjustment of flowrate and diameter of watering. Adjustable from 0 to 60 l./hr. Advised pressure to use, 1,5 bar. Version complete with stake and direct connection to the hose.

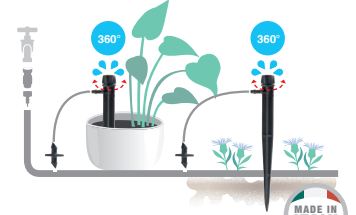
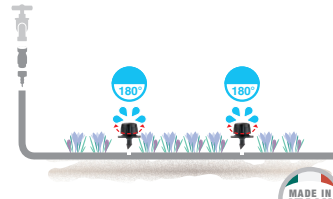
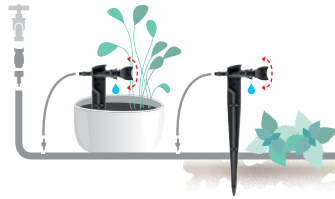
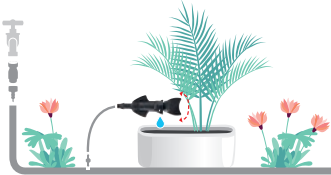

GF80006214

Box (LxWxH) cm 20,7x14,7x10,4

Pcs 10

Kg 0,35



GF80006217

Box (LxWxH) cm 29,7x24,2x11,4

Pcs 5

Kg 0,54



GF80006233

Box (LxWxH) cm 20,7x14,7x10,4

Pcs 10

Kg 0,36



GF80006246

Box (LxWxH) cm 29,7x24,2x11,4

Pcs 5

Kg 0,62



blister
10x

“Ottima 180” adjustable dripper

The click rotation of the head allows simultaneous adjustment of flowrate and diameter of watering. Adjustable from 0 to 60 l./hr. Advised pressure to use, 1,5 bar. Version complete with stake and direct connection to the hose.

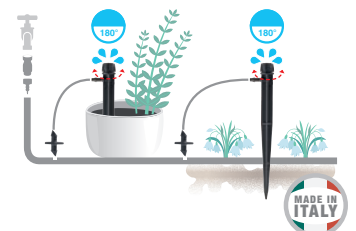

GF80006245

Box (LxWxH) cm 29,7x24,2x11,4

Pcs 5

Kg 0,62





blister
6x



blister
6x



blister
6x

20/ MICRO SPRINKLERS

Standard "orbita" micro-sprinkler

With rotating 360° jet spreader to provide best coverage of the sprinkled area that varies from 6 to 8 m. in diameter.
Working pressure from 1 - 2 bar.
Maximum sprinkling area diam. 6 m.
Maximum flow 47 l./hr.

Adjustable "orbita" micro-sprinkler

With rotating 360° jet spreader to provide best coverage of the sprinkled area that varies from 6 to 8 m. in diameter.
Working pressure from 1 - 2 bar.
Flow changeable from 0 to 105 l./hr.
Maximum sprinkling area diam. from 0 to 8 m.

"Idra 90°" adjustable micro-sprinklers

Adjustable from 0 to 120 l/hr and for 90° surfaces. The tap adjustment permits simultaneous adjustment of flow and watering diameter.
Working pressure from 0.5 – 2.5 bar. Sprinkled area diameter from 0 to 6,6 m

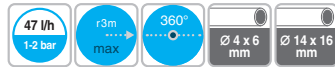
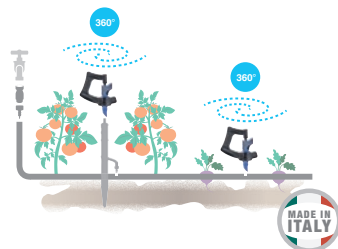

GF80006273	
Box (LxWxH) cm	20,7x14,7x10,4
Pcs	10
Kg	0,31
8 004779 009785	

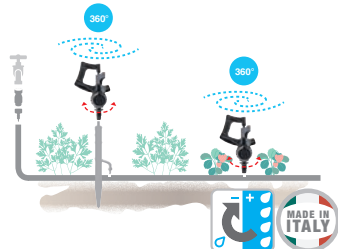

GF80006274	
Box (LxWxH) cm	22,7x15,2x15,4
Pcs	10
Kg	0,47
8 004779 009792	

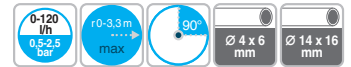
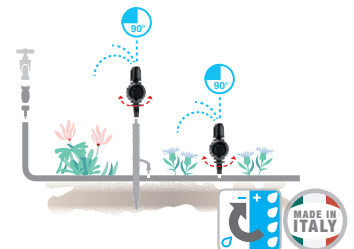

GF80006267	
Box (LxWxH) cm	20,7x14,7x10,4
Pcs	10
Kg	0,34
8 004779 009723	



blister
6x



blister
6x

"Idra 180°" adjustable micro-sprinklers

Adjustable from 0 to 120 l/hr and for 180° surfaces. The tap adjustment permits simultaneous adjustment of flow and watering diameter.
Working pressure from 0.5 – 2.5 bar. Sprinkled area diameter from 0 to 7 m

"Idra 360°" adjustable micro-sprinklers

Adjustable from 0 to 120 l/hr and for 360° surfaces. The tap adjustment permits simultaneous adjustment of flow and watering diameter.
Working pressure from 0.5 – 2.5 bar. Sprinkled area diameter from 0 to 8 m

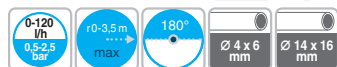
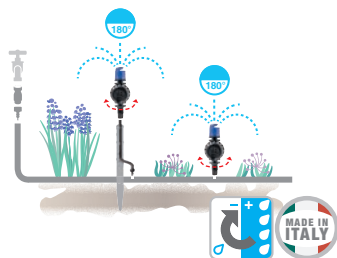

GF80006268	
Box (LxWxH) cm	20,7x14,7x10,4
Pcs	10
Kg	0,33
8 004779 009730	

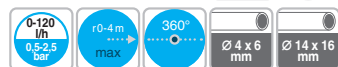
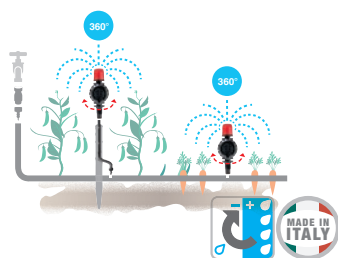

GF80006269	
Box (LxWxH) cm	20,7x14,7x10,4
Pcs	10
Kg	0,33
8 004779 009747	





"Aquila jet" 90° micro-sprinklers

Fixed sprinklers for 90° surfaces. Complete with rapid screw for easy application to extension hoses. Working pressure from 0.5 – 2.5 bar. Maximum sprinkling area diam. 6,2 m. Maximum flow 61 l./hr.



"Aquila jet" 180° micro-sprinklers

Fixed sprinklers for 180° surfaces. Complete with rapid screw for easy application to extension hoses. Working pressure from 0.5 – 2.5 bar. Maximum sprinkling area diam. 4,8 m. Maximum flow 61 l./hr.



"Aquila jet" 360° micro-sprinklers

Fixed sprinklers for 360° surfaces. Complete with rapid screw for easy application to extension hoses. Working pressure from 0.5 – 2.5 bar. Maximum sprinkling area diam. 6,6 m. Maximum flow 61 l./hr.

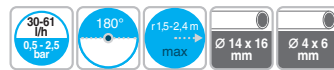
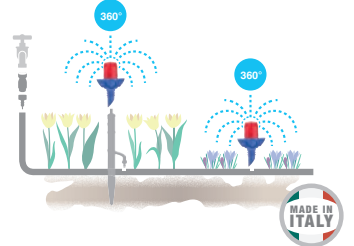
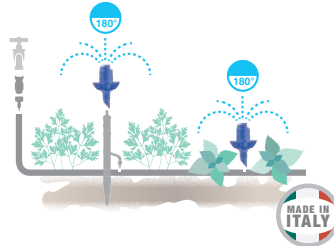
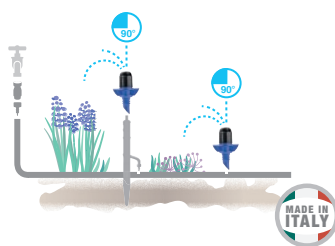

GF80006261	
Box (LxWxH) cm 20,7x14,7x10,4	
Pcs 10	
Kg 0,26	8 004779 009662

GF80006263	
Box (LxWxH) cm 29,7x24,2x11,4	
Pcs 10	
Kg 0,25	8 004779 009686

GF80006265	
Box (LxWxH) cm 30x24x12,5	
Pcs 10	
Kg 0,25	8 004779 009709



"Maxima 360°" micro-sprinklers

The click adjustment on the head allows umbrella flow adjustment both in intensity and surface area until totally closed. Working pressure from 1 - 2 bar. Sprinkling area from 0 to 3.5 m diameter.



"Maxima 360°" micro-sprinklers

The click adjustment on the head allows umbrella flow adjustment both in intensity and surface area until totally closed. Working pressure from 1 - 2 bar. Sprinkling area from 0 to 3.5 m diameter. Version complete with stake and straight connection to the hose.

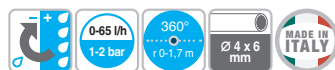
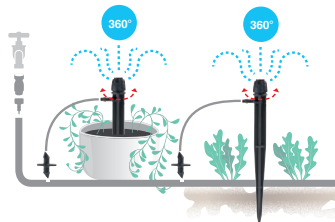
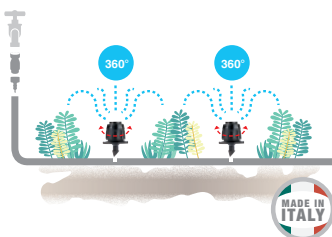

GF80006254	
Box (LxWxH) cm 20,7x14,7x10,4	
Pcs 10	
Kg 0,40	8 004779 009594

GF80006260	
Box (LxWxH) cm 29,7x24,2x11,4	
Pcs 5	
Kg 0,64	8 004779 009655





“Idra 90°” adjustable micro-sprinklers

Adjustable from 0 to 120 l/hr and for 90° sectors. The tap adjustment permits simultaneous adjustment of the flow and watering diameter. Working pressure from 0.5 – 2.5 bar. Maximum sprinkling area 6,6 m diameter. Complete with stakes and hoist tube. Maximum height 30 + 30 cm.

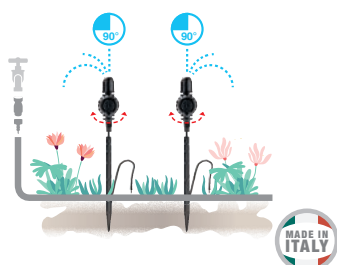

GF80006275	
Box (LxWxH) cm 36x21,5x12	
Pcs 5	
Kg 1,28	8 004779 010026



“Idra 180°” adjustable micro-sprinklers

Adjustable from 0 to 120 l/hr and for 180° sectors. The tap adjustment permits simultaneous adjustment of the flow and watering diameter. Working pressure from 0.5 – 2.5 bar. Maximum sprinkling area 7 m diameter. Complete with stakes and hoist tube. Maximum height 30 + 30 cm.

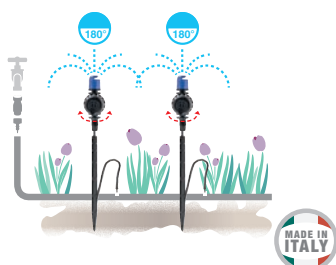

GF80006276	
Box (LxWxH) cm 36x21,5x12	
Pcs 5	
Kg 1,28	8 004779 010033



“Idra 360°” adjustable micro-sprinklers

Adjustable from 0 to 120 l/hr and for 360° sectors. The tap adjustment permits simultaneous adjustment of the flow and watering diameter. Working pressure from 0.5 – 2.5 bar. Maximum sprinkling area 8 m diameter. Complete with stakes and hoist tube. Maximum height 30 + 30 cm.

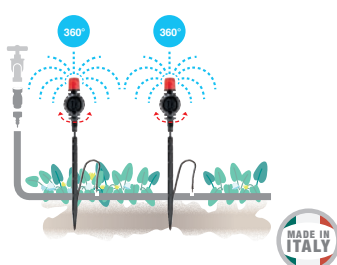

GF80006277	
Box (LxWxH) cm 36x21,5x12	
Pcs 5	
Kg 1,28	8 004779 010040



Hose staff

- Cm 30 h.

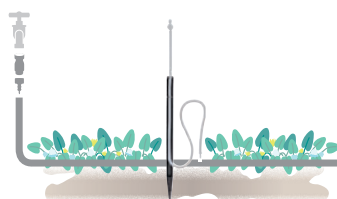

GF80006295	
Box (LxWxH) cm 36x21,5x12	
Pcs 10	
Kg 1,90	8 004779 010309



Hose hoist

- Cm 30 h.
- Complete with connector

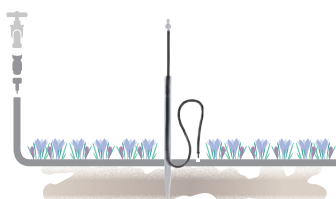

GF80006296	
Box (LxWxH) cm 36x21,5x12	
Pcs 5	
Kg 0,83	8 004779 010316



21/ MAIN LINE ACCESSORIES

Main line accessories
For manifold hose

Accessories suitable for the main line with the attachment to tap or with programmer for manifold hose with diam. 14x16 mm. Ideal for connecting or easily change systems for large terraces and flower beds that require the installation of high water flow main line and a capillary secondary line.



blister
10x

“Straight” connector

- For 14 x 16 hose.

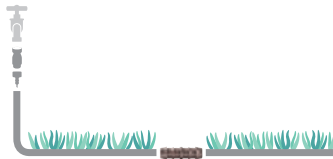

GF80006286	
Box (LxWxH) cm 29,7x24,2x11,4	
Pcs 10	
Kg 0,70	8 004779 010194



blister
10x

“Elbow” connector

- For 14 x 16 hose.

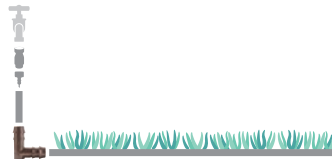

GF80006287	
Box (LxWxH) cm 29,7x24,2x11,4	
Pcs 10	
Kg 0,94	8 004779 010217



blister
10x

“T” connector

- For 14 x 16 hose.

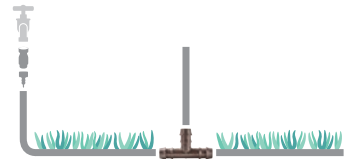

GF80006288	
Box (LxWxH) cm 29,7x24,2x11,4	
Pcs 10	
Kg 1,12	8 004779 010224



Automatic hose connector 14x16

To click-fit the 14x16 collector hose to the tap connector.



3/4" (20-27mm) automatic connector

For connecting to electronic irrigation programmers:

- Pressure reducer
- 1/4" connector for capillary hose
- 1/2" connector for collector hose
- Other accessories with 3/4" thread

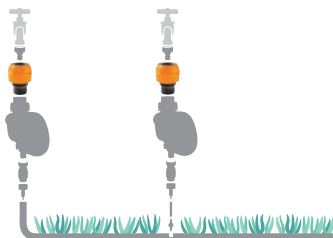

GF80006600	
Box (LxWxH) cm 20,7x14,7x10,4	
Pcs 10	
Kg 0,25	8 004779 036583



GF80006601	
Box (LxWxH) cm 20,7x14,7x10,4	
Pcs 10	
Kg 0,23	8 004779 036576



blister
1x

In-line tap

- For 14 x 16 manifold hose

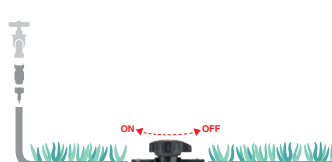

GF80006280	
Box (LxWxH) cm 15x15x12	
Pcs 5	
Kg 0,23	8 004779 010088



blister
10x

“Manifold hose” stake

- For 14 x 16 hose.



GF80006278	
Box (LxWxH) cm 37,5x24x19,5	
Pcs 10	
Kg 1,73	8 004779 010064



blister
1x

Hose piercer

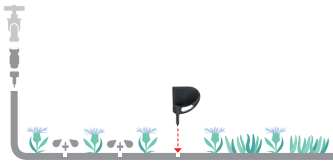

GF80006294

Box (LxWxH) cm **15x15x12**



Pcs 5

Kg 0,13



25m
14x16mm

14 x 16 manifold hose

- 25 metres



GF80006298

Box (LxWxH) cm **ø 39x13**



Pcs 1

Kg 1,37



blister
10x

“Hose Clamping” band

- For hoses from 16 to 18 ext. diam.



blister
10x

“End of line” plug

- For 14 x 16 hose.



blister
10x

Repair patches

- For use in case of incorrect hole positioning on the main line

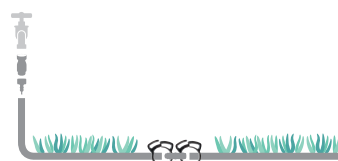

GF80006292

Box (LxWxH) cm **22,7x15,2x15,4**



Pcs 10

Kg 0,55

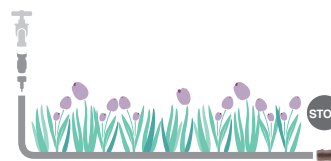

GF80006289

Box (LxWxH) cm **20,7x14,7x10,4**



Pcs 10

Kg 0,37



GF80006272

Box (LxWxH) cm **21x16x11**



Pcs 10

Kg 0,18





In-line tap

- For 4 x 6 capillary hose.

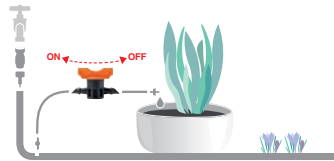

ON OFF
Ø 4 x 6 mm
MADE IN ITALY

GF80006279
Box (LxWxH) cm **20,7x14,7x10,4**
Pcs 10
Kg 0,24



“Straight” connector

- For 4 x 6 hose

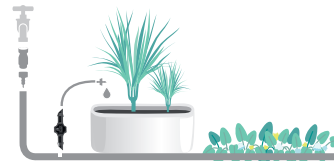

in out
Ø 14 x 16 mm Ø 4 x 6 mm
MADE IN ITALY

GF80006281
Box (LxWxH) cm **20,7x14,7x10,4**
Pcs 10
Kg 0,23



“Elbow” connector

- For 4 x 6 hose

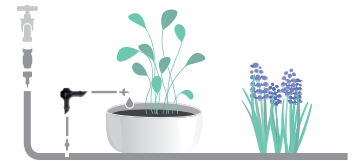

Ø 4 x 6 mm
MADE IN ITALY

GF80006283
Box (LxWxH) cm **20,7x14,7x10,4**
Pcs 10
Kg 0,23

**22/
SECONDARY
LINE
ACCESSORIES**

Secondary line accessories
For capillary hose

Accessories indicated for capillary HOSE of diam. 4x6 mm, suitable both for direct line with attachment to the tap or with programmer, that for the secondary line. Ideal for connecting or easily modify systems for balconies, small terraces or flower beds that require the installation of a direct line with reduced capacity.



“T” connector

- For 4 x 6 hose

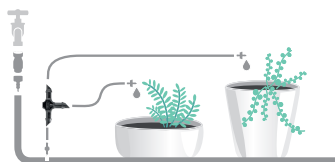

Ø 4 x 6 mm
MADE IN ITALY

GF80006282
Box (LxWxH) cm **20,7x14,7x10,4**
Pcs 10
Kg 0,24



“Cross” connector

- For 4 x 6 hose



Ø 4 x 6 mm
MADE IN ITALY

GF80006284
Box (LxWxH) cm **20,7x14,7x10,4**
Pcs 10
Kg 0,25



“End of line” plug

- For 4 x 6 hose



Ø 4 x 6 mm
MADE IN ITALY

GF80006285
Box (LxWxH) cm **20,7x14,7x10,4**
Pcs 10
Kg 0,22



“Capillary tube” stake

- For 4 x 6 hose

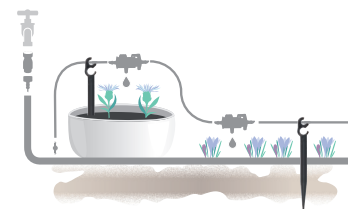

Ø 4 x 6 mm
MADE IN ITALY

GF80006222
Box (LxWxH) cm **29,7x24,2x11,4**
Pcs 10
Kg 0,55

MICRO IRRIGATION DRIP IRRIGATION



blister
5x

Micro saddle

Useful innovative system to puncture holes and at the same time tighten the hose of the main line. Once positioned it makes it extremely simple to provide a direct secondary connection to drippers and microsprayers both "in line" and "end line".



GF80006271

Box (LxWxH) cm **21x16x11,5**

Pcs 10

Kg 0,25



1x

Line filter

- Inlet diameter 14 mm
- Outlet diameter 14 mm + 4 mm
- Flow 35 l/minute



1x

Pressure reducer

- Threaded 3/4" + 3/4"
- Outlet pressure approx. 1.2 bar.

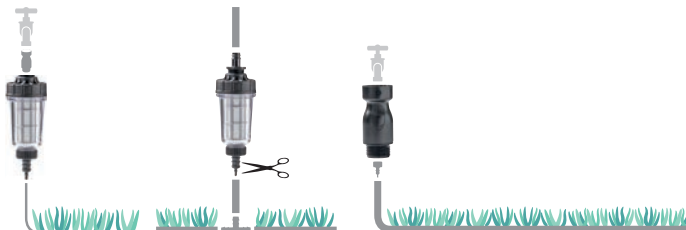

GF80006293

Box (LxWxH) cm **29,7x24,2x11,4**

Pcs 5

Kg 0,82



GF80006291

Box (LxWxH) cm **22,7x15,2x15,4**

Pcs 10

Kg 0,53



20m
4x6mm

4 x 6 capillary hose

- 20 metres

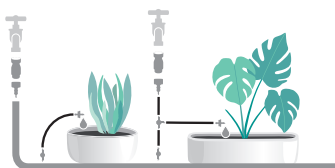

GF80006297

Box (LxWxH) cm **37,5x25,5x15**

Pcs 5

Kg 2,70





"12 Vase" mini dripper kit

Complete collection for balcony, terrace or small flowerbeds.

- 1 pressure reducer
- 1 3/4" tap connector
- 12 m of capillary hose
- 12 T connectors
- 12 support rods
- 12 end of line drippers
- 2 end of line plugs



"12 Vase" dripper kit

Complete collection for balcony, terrace or small flowerbeds.

- 1 pressure reducer
- 1 3/4" tap connector
- 20 m of capillary hose
- 4 T connectors
- 4 L connectors
- 12 support rods
- 10 line drippers
- 2 end of line drippers
- 2 end of line plugs



"20 Vase" dripper kit

Complete collection for balcony, terrace or flowerbeds

- 1 pressure reducer
- 1 3/4" tap connector for hose diam. 14x16 mm and 4x6 mm
- 25 m of manifold hose diam. 14x16 mm
- 20 m of capillary hose diam. 4x6 mm
- 20 "Ottima 360°" drippers adjustable from 0 to 60 l./hr. Stake version.
- 3 rubber connectors for hose diam. 14x16 mm
- 2 straight connectors for hose diam. 14x16 mm
- 1 end of line plug for hose diam. 14x16 mm
- 1 tube piercer



Tap connector

- For 3/4" taps
- For 14 x 16 and 4 x 6 hose

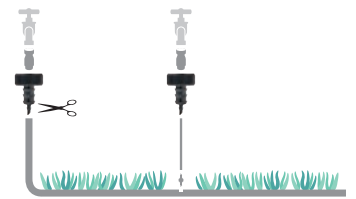
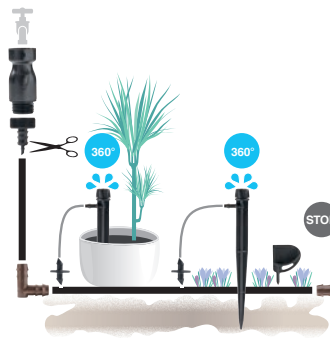
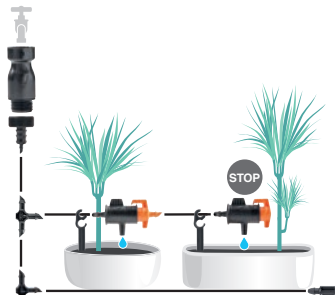
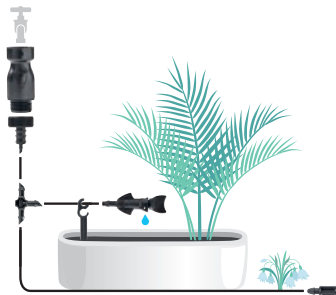

GF80006299	
Box (LxWxH) cm 40x28x20,5	
Pcs 10	
Kg 5,30	8 004779 009471

GF80006101	
Box (LxWxH) cm 29,7x25,7x25,4	
Pcs 4	
Kg 3,72	8 004779 061011

GF80006105	
Box (LxWxH) cm 40x16x40	
Pcs 1	
Kg 2,25	8 004779 012808

GF80006290	
Box (LxWxH) cm 22,7x15,2x15,4	
Pcs 10	
Kg 0,33	8 004779 010255



25m
ø25mm

25 mm polyethylene hosepipe

Hosepipe for PN4 compression couplings
• 25 meters



15m
ø1/2"

1/2" diam. porous hosepipe

Ideal for localised watering of groups of plants, hedges, flowerbeds, vegetable gardens and orchards. The slow and continuous release manages to save up to 50% of water perfectly maintaining damp soil and avoiding excessive evaporation.

- 15 meters
- Complete with end of line cap
- Male connection
- Maximum pressure in use of 2 bar (see page 41)



25m
ø16mm

16 mm external diam. dripper hosepipe

Hose for localised watering of orchards, flowerbeds and plants, constantly maintaining damp soil avoiding excessive evaporation and allowing water savings up to 50%.

- 25 meters
- 30 cm spacing
- Flow 2.1 l/hr

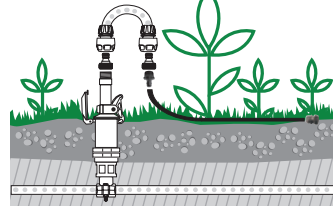
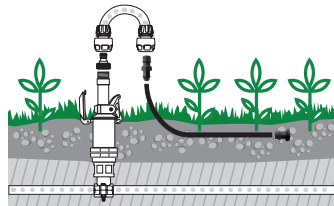
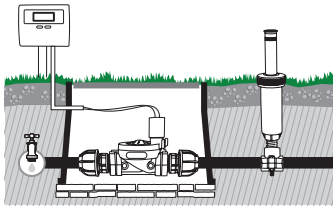
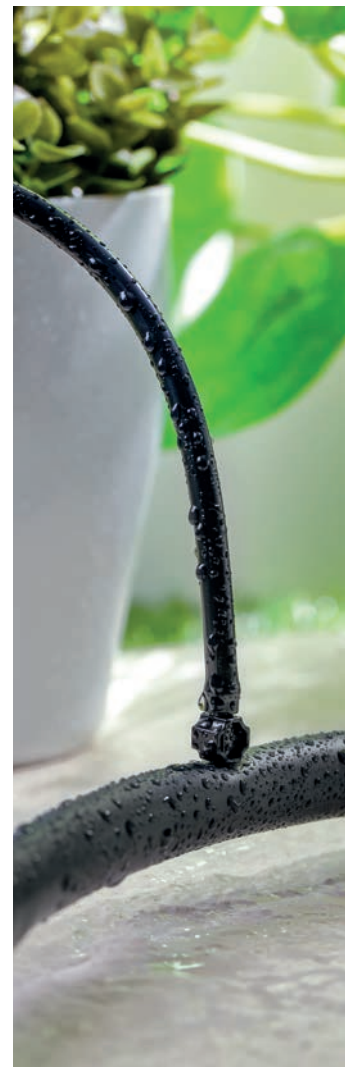

GF80002302

Box (LxWxH) cm ø 56x16



Pcs 1

Kg 3,28

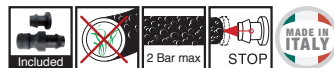

GF80002300

Box (LxWxH) cm ø 30x10



Pcs 1

Kg 1,36



GF80002301

Box (LxWxH) cm ø 30x11



Pcs 1

Kg 1,57



blister
10x



blister
1x



blister
2x



blister
2x



blister
2x



blister
1x

Stake for soaker hoses

• For tubing of 14-6 mm

Connection kit for soaker hoses

ø 14-16 mm, composed of:

- 1 T connector
- 2 elbow connectors
- 2 straight connectors

Connection kit for soaker hoses

Diameter 14-16 mm, composed of:

- 1 threaded coupling
- 2 end of plugs

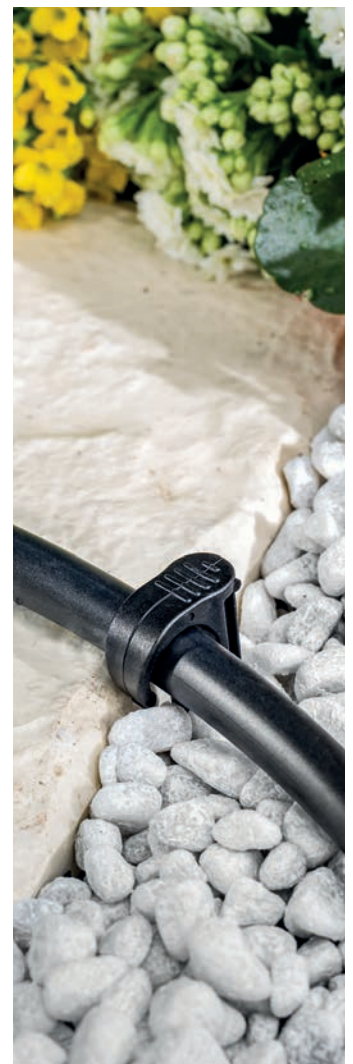
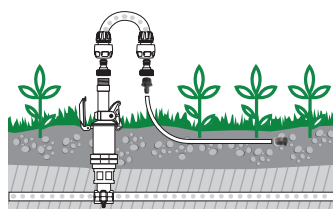
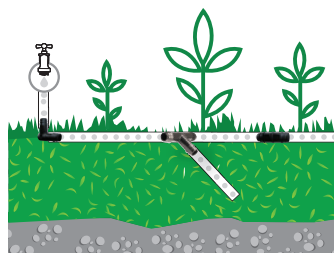
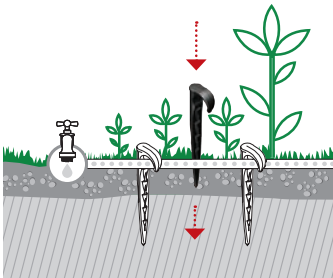

GF80006278

Box (LxWxH) cm 37,5x24x19,5



Pcs 10

Kg 1,73



GF80002275

Box (LxWxH) cm 20,7x14,7x10,4



Pcs 10

Kg 0,47



GF80002276

Box (LxWxH) cm 20,7x14,7x10,4



Pcs 10

Kg 0,32





Geared rotating brush

Rotating brush for car washing with a system of gearing that allows it to be used even at low pressures.

- Edge in soft shock-resistant polypropylene
- External body in transparent polycarbonate
- Bristles in soft plumed anti-scratch PVC



Geared rotating brush kit

Rotating brush for car washing with a system of gearing that allows it to be used even at low pressures.

- Edge in soft shock-resistant polypropylene
- External body in transparent polycarbonate
- Bristles in soft plumed anti-scratch PVC
- Spray nozzle
- Hose connector with tap adjustment



"Promotional" fixed brush

Practical and inexpensive brush for car washing

- Constructed from soft shock-resistant materials



"Promotional" fixed brush kit

Contains:

- Fixed brush
- Hose connector with tap adjustment

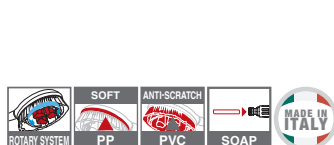

GF80005175	
Box (LxWxH) cm 40x28x20,5	
	Pcs 6
Kg 2,47	

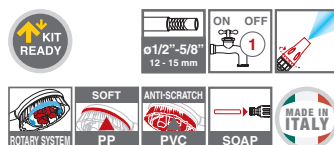

GF80005233	
Box (LxWxH) cm 46x46,5x19,5	
	Pcs 6
Kg 4,16	



GF80005218	
Box (LxWxH) cm 36,5x27,5x39	
	Pcs 12
Kg 2,49	

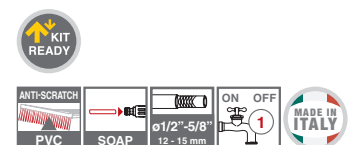

GF80005224	
Box (LxWxH) cm 57x48x19,5	
	Pcs 12
Kg 4,07	

Garden shower

A "use-anywhere" shower connected to the water supply. Consisting of dismantlable pipe-work in anodised aluminium and stable tripod stand. With a tap for flow adjustment and turning off the water. Useful height 2 m.

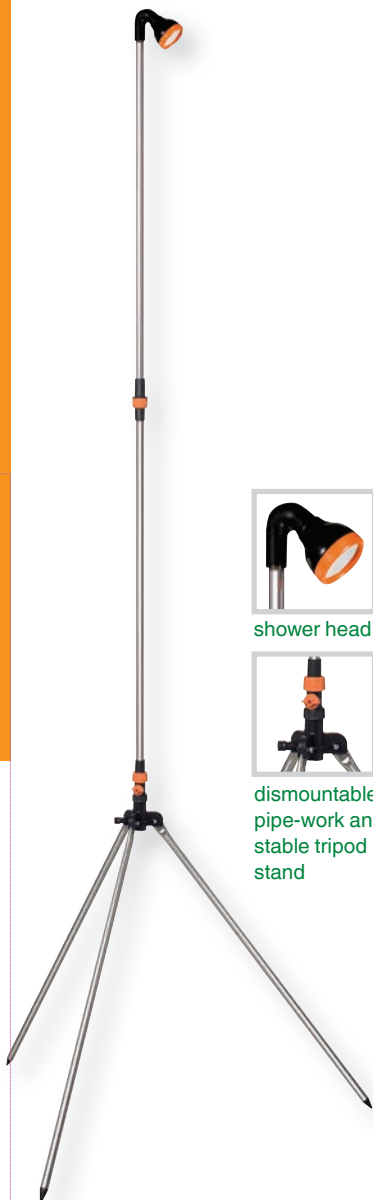

shower head



dismountable pipe-work and stable tripod stand



GF80005461

Box (LxWxH) cm **80x24x17**

Pcs 4

Kg 3,85



ElectricWeeder

Delivers a thermal shock to the weed (up to 650°) that will destroy the plant cells and the weed in just a few seconds.

ECO-FRIENDLY : no chemicals, pesticides and gas are used so there are no CO2 emissions and no waste.

SAFE : no flame. The hook at the back allows the product to be placed horizontally on the floor, without the nozzle touching the ground, so that the product cools down safely.

ECONOMICAL : no consumables to replace e.g. gas or pipe. 10 times less expensive than a gas weeder.

EFFECTIVE AND ROBUST : destroys the plant cells and the weed in just a few seconds. Motor with robust heating elements, providing the GF Electric Weeder with a long service life.

PRECISE : 2 nozzles included :

A round nozzle, ideal for removing weeds from the lawn, flower beds, or vegetable garden. A flat nozzle for precise weeding of borders.

ENGINE POWER : 2000W

ERGONOMIC : comfortable to use thanks to its 116 cm length. Ergonomic handle with easy-to-use power button

Included:

- 1 cone nozzle (pre-fitted) • 1 flat nozzle • 1 set of operating instructions

Technical data:

Rated voltage 230 V - 50 Hz (alternative current)

Rated power consumption: max. 2000 W

Temperature (nozzle outlet): approx 650°

Protection class: II/ (double insulation)



Ergonomic handle



ON/OFF switch



Stand



1 ERGONOMIC ON-OFF



2 BEFORE ... THERMAL SHOCK



3 ... AFTER 2 DAYS



ACCESSORY INCLUDED

NEW



AQUAPOP GREY PRO 15/25 m
Textile self-extendable hose
Made in Italy

- self-extendable hose of various lengths
- mini ergonomic lance or 8-jet ergonomic lance
- click-fit hose connectors, 3/4" tap connector
- container designed to facilitate storage and tap coupling system

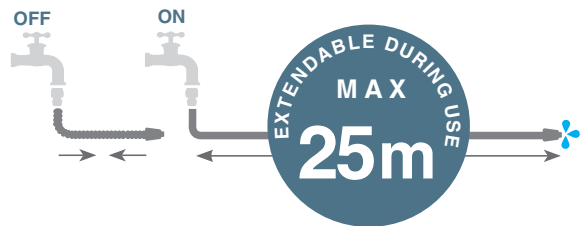
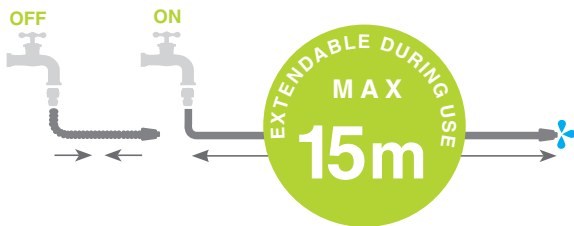

GF80287677	
Box (LxWxH) cm 40x35,5x35	
Pcs 2	
Kg 2	

GF80287678	
Box (LxWxH) cm 40x35,5x35	
Pcs 2	
Kg 4,8	



AQUAPOP GREY EASY 10/15/25/30 m

Textile self-extendable hose Made in Italy

- self-extendable hose of various lengths
- mini lance
- click-fit hose connectors
- 3/4" tap connector

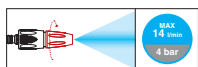

GF80297672	
Box (LxWxH) cm 25,5x9,7x25,5	
10m	Pcs 1
Kg 0,9	
8 004779 040108	

GF80297675	
Box (LxWxH) cm 25,5x14,5x25,5	
25m	Pcs 1
Kg 1,55	
8 004779 040139	



GF80297673	
Box (LxWxH) cm 25,5x9,7x25,5	
15m	Pcs 1
Kg 1	
8 004779 040115	

GF80297676	
Box (LxWxH) cm 25,5x14,5x25,5	
30m	Pcs 1
Kg 1,88	
8 004779 040146	



AQUAPOP GREY 25

Textile self-extendable hose Made in Italy

- self-extendable up to 25m
- 8-jet ergonomic lance
- click-fit hose connectors, 3/4" tap connector
- container bag



GF80297686	
Box (LxWxH) cm 40,5x35,5x35	
25m	Pcs 2
Kg 4,5	
8 004779 040306	

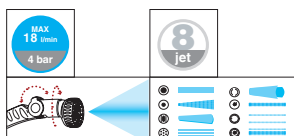

"AQUAPOP" self-extendable hose kit

Self-extendable hose kit for watering plants and flowers and for cleaning outdoor surfaces. Ideal for gardens, patios and balconies. After use, the empty hose retracts to extremely compact dimensions so it occupies minimal space in the practical container supplied, designed to facilitate storage.

- self-extendable hose of various lengths
- mini ergonomic lance or 3 jet ergonomic lance
- click-fit hose connectors
- 3/4" tap connector

aquapop¹⁵



from 5 to
15 m
at 4 bar pressure

aquapop³⁰



from 10 to
30 m
at 4 bar pressure

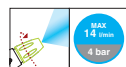
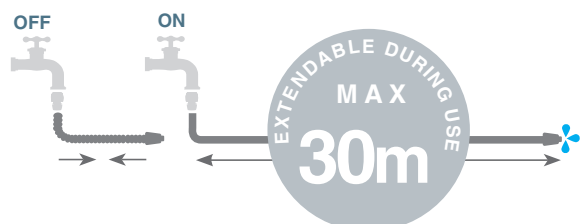
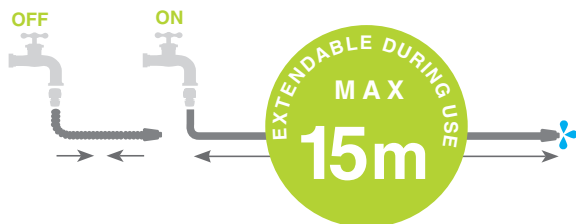

GF80287600	
Box (LxWxH) cm 42x36x24	
Pcs 2	
Kg 2,6	8 004779 025914

GF80277600	
Box (LxWxH) cm 42x36x24	
Pcs 2	
Kg 2,6	8 004779 025907

GF80287603	
Box (LxWxH) cm 40,5x35,5x35	
Pcs 2	
Kg 4,5	8 004779 027697

GF80277603	
Box (LxWxH) cm 40,5x35,5x35	
Pcs 2	
Kg 4,5	8 004779 027680

GF80267600	
Box (LxWxH) cm 42x36x24	
Pcs 2	
Kg 2,6	8 004779 025891

GF80297600	
Box (LxWxH) cm 42x36x24	
Pcs 2	
Kg 2,6	8 004779 025921

GF80267603	
Box (LxWxH) cm 40,5x35,5x35	
Pcs 2	
Kg 4,5	8 004779 027673

GF80297603	
Box (LxWxH) cm 40,5x35,5x35	
Pcs 2	
Kg 4,5	8 004779 027703

aqua@o

"AQUAGO" self-extending hose kit

Ideal for gardens, terraces or balconies.

After use, the empty hose shortens on its own to a compact size.

Lightweight and manageable, thanks to its structure it's also anti-kink, anti-twist and flexible even at low temperatures. In case of breakage or puncture, it can be cut and reconnected.

The kit includes:

- Self-extending hose up to 30 metres
- Mini ergonomic nozzle or 8-jet ergonomic nozzle
- Click-fit hose connectors • 3/4" tap connector
- Aquago Bunny 25 version: container and tap coupling system

aqua@o bunny25

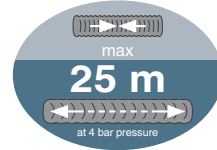

AVAILABLE WHILE STOCK LAST

AVAILABLE WHILE STOCK LAST

AVAILABLE WHILE STOCK LAST

AVAILABLE WHILE SUPPLIES LAST



GF80007652	
Box (LxWxH) cm 40,5x35,5x35	
	Pcs 2
Kg 4,3	

GF80007653	
Box (LxWxH) cm 40,5x35,5x35	
	Pcs 2
Kg 4,3	

GF80007654	
Box (LxWxH) cm 40,5x35,5x35	
	Pcs 2
Kg 4,3	

GF80007655	
Box (LxWxH) cm 40,5x35,5x35	
	Pcs 2
Kg 4,3	

aqua@o easy15

aqua@o easy30

ONLY FOR aqua@o



AVAILABLE WHILE STOCK LAST



GF80297646	
Box (LxWxH) cm 23,5x24x11,5	
	Pcs 1
kg 0,85	

GF80297647	
Box (LxWxH) cm 23,5x24x15	
	Pcs 1
kg 1,4	



GF80043700	
Box (LxWxH) cm 14,5x14,5x11	
	Pcs 15
kg 0,55	

"AQUALIGHT" light hose kit

AquaLight is the innovative, super-light and anti-knot hose. Lightweight and manageable. Anti-kink and anti-twist construction. Durable and flexible even at low temperatures. Easy to roll up and store. Easy to repair in case of cuts or punctures. Up to 3 times lighter than a traditional hose. 100% recyclable hose, disposed of with other plastics (excluding accessories).

- AQUALIGHT 15 KIT: "8 jet" gun

aqualight



aqualight
15 KIT

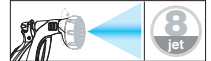
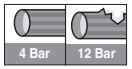

GF80287156	
Box (LxWxH) cm 12x29x33	
Pcs 1	
kg 1,5	8 004779 038785



aqualight
15

aqualight
30

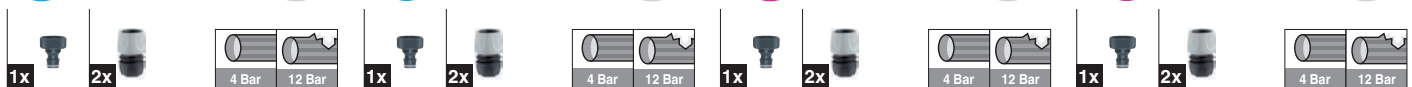

GF80007151	
Box (LxWxH) cm 30x26x11,5	
Pcs 1	
kg 1,2	8 004779 036156

GF80007153	
Box (LxWxH) cm 32x28x13	
Pcs 1	
kg 2,4	8 004779 036170

GF80007152	
Box (LxWxH) cm 30x26x19	
Pcs 1	
kg 2,2	8 004779 036163

GF80007154	
Box (LxWxH) cm 32x28x25	
Pcs 1	
kg 4,4	8 004779 036187

“AQUABAG STYLE” Mini hose reel

The new mini version hose reel is ideal for watering plants, flowers and pots on patios, balconies, verandas and small gardens.

Thanks to its dual purpose design - floor standing or portable - this is a product that proves highly practical.

It is equipped with:

- 11,5 meters of braided flexible hose (10 m rewinding inside + 1,5 m outside)
- 2 Soft Touch quick –click hose connectors
- 8 jet ergonomic nozzle
- 3/4" adaptor

rewindable and portable / dual purpose / storable and wall-mountable

aquabag
style

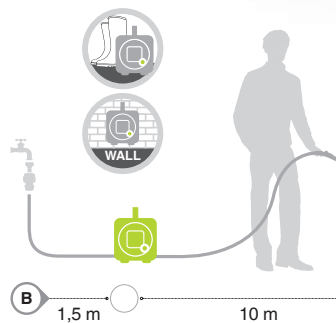
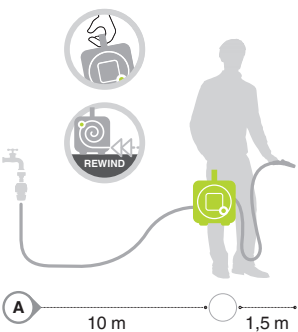
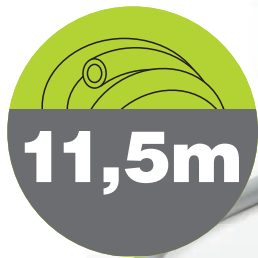

GF80285628	
Box (LxWxH) cm 33x30x31,5	
	Pcs 2
Kg 4,5	

GF80275628	
Box (LxWxH) cm 33x30x31,5	
	Pcs 2
Kg 4,5	

GF80265628	
Box (LxWxH) cm 33x30x31,5	
	Pcs 2
Kg 4,5	

aqualbag MAXI



"AQUABAG MAXI" Portable hose-reel

Designed for any application that requires a compact product, it is ideal for balconies, terraces, medium-sized gardens. Manually rewinding, portable, easy to store.

- 16,5 meters of braided flexible hose (15 m rewinding inside + 1,5 m outside)
- 2 Soft Touch quick-click hose connectors
- 8 jet ergonomic nozzle
- "indoor-outdoor" 3/4" adaptor, ideal for any type of tap, also for those used indoors (for example: kitchen, bathroom, laundry....)

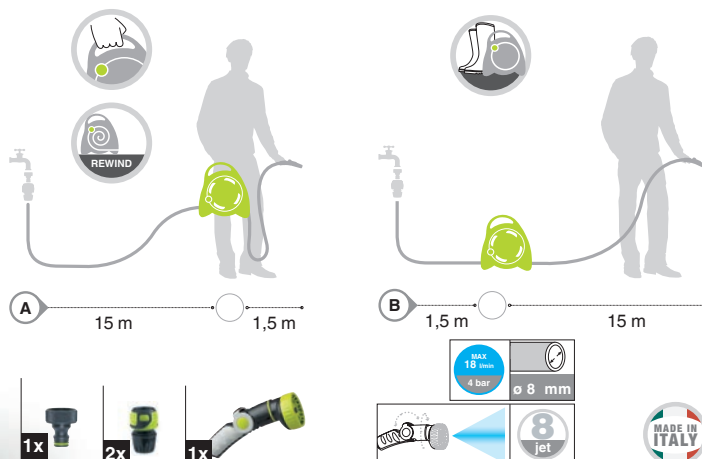

GF80285608	
Box (LxWxH) cm 42x36x35	
Pcs 2	
Kg 7	8 004779 023217

GF80275608	
Box (LxWxH) cm 42x36x35	
Pcs 2	
Kg7	8 004779 023200

GF80265608	
Box (LxWxH) cm 42x36x35	
Pcs 2	
Kg 7	8 004779 023194

GF80295608	
Box (LxWxH) cm 42x36x35	
Pcs 2	
Kg 7	8 004779 023224

aqualbalcony

AQUABALCONY - Hose hanger kit with 10 m hose

Ideal for watering plants, flowers and pots on patios, balconies, verandas and small gardens. Thanks to the dual method of use, this product can be placed on the ground or transported. It is also extremely practical. It can be also wall-mounted. Equipped with:

- 10 metres of flexible hose
- 2 quick connectors
- 8 jet ergonomic nozzle
- 3/4" tap connector



1x	2x	1x
GF80285852		
Box (LxWxH) cm 64x29x32		
Pcs 6		
Kg 7,5	8 004779 030697	

GF80275852			
Box (LxWxH) cm 64x29x32			
Pcs 6			
Kg 7,5	8 004779 030680		

GF80265852		
Box (LxWxH) cm 64x29x32		
Pcs 6		
Kg 7,5	8 004779 030673	

GF80295852	
Box (LxWxH) cm 64x29x32	
Pcs 6	
Kg 7,5	8 004779 030710

REWALL™ style

wall automatic hose reel

- “REWall Style” automatic wall-mounted hose-reel**
 Fixed to a wall, it automatically and easily retracts the hose, without the need of force. Revolves 180° thanks to a wall bracket.
- 35 m. of reinforced 1/2" hose;
 - AQUASTOP SOFT TOUCH 1/2" hose connector to automatically stop the water;
 - Spray nozzle with adjustable jet from fine atomized cone to straight jet;
 - Tap connector kit: 1.5m reinforced 1/2" hose, SOFT TOUCH 1/2" hose connector, tap plug
 - Kit of 3 coloured covers (Lime, Grey, Sage)

EASY GUIDE

180°

SLOW RETURN

STOP ANY WHERE

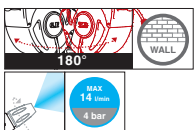

GF80005864	
Box (LxWxH) cm 62x28x51	
	Pcs 1
Kg 16,00	



Concept Easy Guide hose reel kit, with super light Aqualight 30 hose.

Plastic and metal hose reel trolley, practical thanks to the hose-guide system to facilitate hose rewinding. It is very light thanks to the hose supplied that is up to 3 times lighter than a traditional hose. Thanks to the telescopic handle it is not bulky and is easy to store even in small spaces. Fully assembled and equipped.

- 8 jet gun
- 4 SOFT TOUCH automatic connectors 1/2" - 5/8" (12 - 15 mm)
- 1 tap connector 3/4" (20 - 27 mm)
- Aqualight 30 m superlight hose 5/8"



3x	1x	1x	1x	
GF80285866				
Box (LxWxH) cm 80x120x55				
Pcs 6				
Kg 30				

ø1/2"-5/8" 12 - 15 mm	ø 1/2" 60 m	ø 5/8" 50 m	ø 3/4" 40 m	
	8	jet	MAX 18 bar	4 bar

Concept Easy Guide hose reel kit

Plastic and metal hose reel trolley, practical thanks to the hose-guide system to facilitate hose rewinding. Thanks to the telescopic handle it is not bulky and is easy to store even in small spaces. Fully assembled and equipped.

- 8 jet gun
- 4 SOFT TOUCH automatic connectors 1/2" - 5/8" (12 - 15 mm)
- 1 tap connector 3/4" (20 - 27 mm)
- 30 m hose with Ø 5/8"

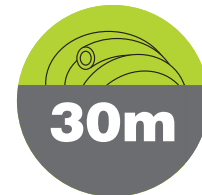

3x	1x	1x	1x	
GF80285868				
Box (LxWxH) cm 80x120x55				
Pcs 6				
Kg 36				

ø1/2"-5/8" 12 - 15 mm	ø 1/2" 60 m	ø 5/8" 50 m	ø 3/4" 40 m	
	8	jet	MAX 18 bar	4 bar



“CONCEPT PLUS“ hose reel kit
 Plastic and metal hose reel trolley. Thanks to the telescopic handle, it is compact and easy to store even in small spaces. Fully assembled and equipped

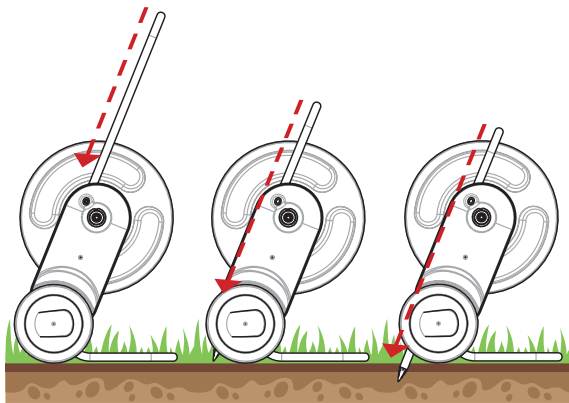
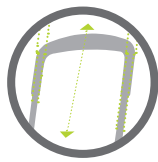

CONCEPT PLUS

“CONCEPT PLUS READY 25” hose reel kit

- trolley with wheels and retractable telescopic handle
- “8 jet Easy Plus” gun • 4 SOFT TOUCH “quick click” hose connectors
- 1 Ø 3/4” tap adaptor • 25 m hose with Ø 1/2” or 5/8”



25m



CONCEPT PLUS tubo 5/8”

GF80285822	
Box (LxWxH) cm 80x120x55	
Pcs 6	
Kg 38	8 004779 027659

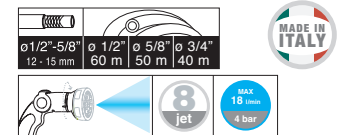

CONCEPT PLUS tubo 1/2”

GF80285820	
Box (LxWxH) cm 80x120x55	
Pcs 6	
Kg 33	8 004779 027338



CONCEPT PLUS METAL

“CONCEPT PLUS METAL” hose reel kit

- trolley with wheels and retractable telescopic handle
- “8 jet Easy Plus” gun • 4 SOFT TOUCH “quick click” hose connectors
- 1 Ø 3/4” tap adaptor • 25 m hose with Ø 1/2”
- Steel discs and drum with anticorrosion treatment



25m



CONCEPT PLUS tubo 1/2”

GF80285856	
Box (LxWxH) cm 80x120x55	
Pcs 6	
Kg 33	8 004779 033476

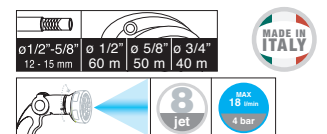



Hose hanger

Ideal for both conventional flexible garden hoses and for self-extendable hoses. Dual use: can be attached to a tap or wall-mounted.



Trolley/tap connecting kit

- 1,5 m of wired 1/2" hosepipe
- 2 click-fit 1/2" hose connectors
- 3/4" tap connector

GFPRO
ECO WATERING COMPUTER

Bluetooth®



Bluetooth® GFPRO Eco Watering Computer

Easy to use, it allows irrigation programming by connecting the device to the programmer via **Bluetooth® wireless technology**. Through the control panel of the **GF App** it is possible to:

- **Set up customized programs:** for a maximum of 4 daily irrigations.
- **Set up predefined programs:** differentiated between surface irrigation and Micro/Drip irrigation.
- **Set up the ECO function:** it adjusts the duration of the programs previously set according to the current season.
- **Manually adjust the programmed watering duration:** it is possible to increase or decrease the duration of the programs previously set based on warmer or rainier weather forecasts for the next 3 days.
- **Manually open or close the water flow.**
- **Combine the app and simultaneously manage multiple GFPRO Eco Watering Computer programmers.**



GF80287044	
Box (LxWxH) cm 58x20x11,5	
	Pcs 8
Kg 1,1	

GF80287234	
Box (LxWxH) cm 29,7x25,7x25,4	
	Pcs 6
Kg 2,54	

CONCEPT

CONCEPT



"CONCEPT"

Plastic and metal hose reel trolley. Thanks to the telescopic handle, it is compact and easy to store even in small spaces. Fully assembled and equipped.

- trolley with wheels and retractable telescopic handle
- max. capacity 60m of 1/2" Ø hose
- complete with hose holder click connectors



"MINI CONCEPT READY 15" portable kit

Transportable and wall hanging thanks to the appropriate supports (not supplied). Already assembled and equipped with 15 m of hose, connectors and "3 JET" ergonomically-designed nozzle.



3x	
ø 1/2" - 5/8 12x15 mm	ø 1/2" - 5/8" - 3/4" 60 m 50 m 40 m
MADE IN ITALY	

GF80285795	
Box (LxWxH) cm 38,5x14,5x55	
	Pcs 1
Kg 2,5	

1x		1x		1x	
ø 1/2" - 5/8 12x15 mm	ø 1/2"	ø 5/8"	ø 3/4"	MADE IN ITALY	

GF80285793	
Box (LxWxH) cm 80x120x28	
	Pcs 12
Kg 30	

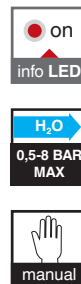
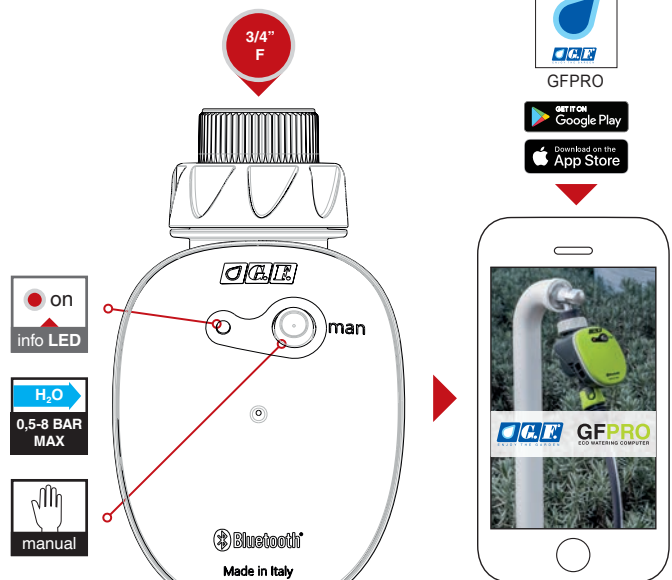

GFPRO





"GF16 EASY"

Electronic programmer

Simple and trustworthy, provides combinations of programs up to 16 possibilities managed through the easy to use knob switch. Starts every 6, 12, 24, 48 hours with prefixed watering times. "Easy garden" program for the optimization of the watering cycles: two preset daily watering to water properly morning and evening, improving the absorption of water by the soil, thus avoiding the plants damaging.

- manual start button for starting independently of the programme cycle
- works with 9 volt alkaline battery
- device to stop the water flow in case the battery runs down
- electrical components protected from water and humidity
- 3/4" attachment to tap
- maximum pressure in use 8 Bar

"GF48" Electronic programmer

It is simple, easy to understand and practical to be used, it is possible to select programs easily managed up to 48 possibilities controlled through the easy to use concentric knob switches.

- manual start button for starting independently of the program cycle
- button for delaying of 8 hours after the initial setting-up
- works with 9 volt alkaline battery
- device to stop the water flow in case the battery runs down
- electrical components protected from water and humidity
- 3/4" attachment to tap
- maximum pressure in use 8 Bar

Stand-alone drip watering system for pot plants.

Simple and practical, all that the aquaflo holiday system requires in order to function is a plastic drinks bottle of 0.5 to 2 litres capacity. No need to move any plant from its usual place, and no need for makeshift connections to the water supply.

- **simplicity:** to start watering, just attach a plastic bottle filled with water to the spike, pierce a small hole in the upturned bottom so that air can escape, then push the spike into the soil and adjust the flow of water as required.
- **effective watering:** the aquaflo holiday incorporates a special outlet grille that delivers each successive drip directly to the roots, avoiding waste and evaporation of the water.
- **adaptability:** suitable for any kind of pot or planter, whatever the size and shape.
- **indoor and outdoor use**



UNIVERSAL FITTING FOR PLASTIC BOTTLES OF 0.5 UP TO 2 LITRES

FLOW RATE ADJUSTER

CONSTANT DRIP WATERING DELIVERED DIRECT TO PLANT ROOTS

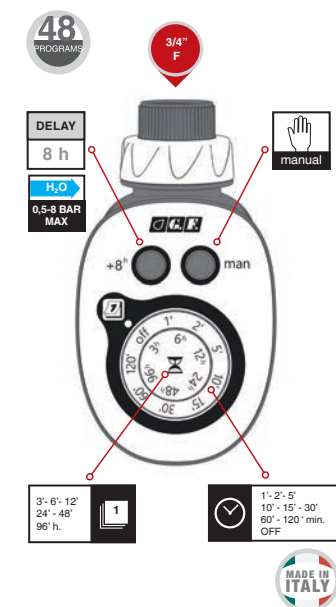
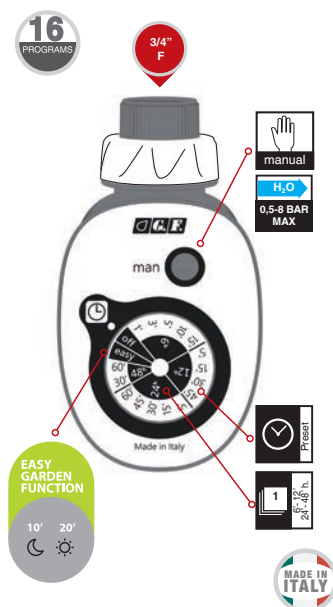
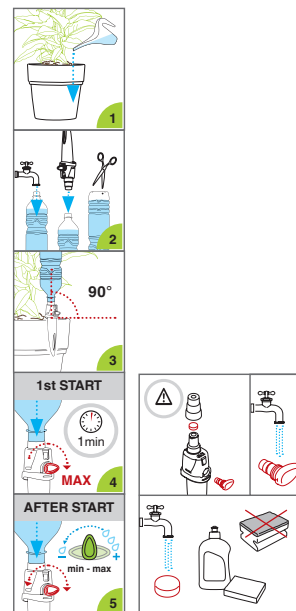

"AQUAFLO HOLIDAY" Mix color

A drip watering system for pot plants that will keep all house plants regularly watered during excursions, trips and holidays.

"AQUAFLO HOLIDAY TRIS" Mix color

Practical hang-pack containing 3 pieces



GF80286016	
Box (LxWxH) cm 18x19x12	
Pcs 2	
Kg 1	8 004779 022975

GF80286015	
Box (LxWxH) cm 18x19x12	
Pcs 2	
Kg 1	8 004779 023682

GF80256343	
Box (LxWxH) cm 38,5x29x30	
Pcs 24	
Kg 2	8 004779 023330

GF80256344	
Box (LxWxH) cm 37x24x19,5	
Pcs 6	
Kg 1,4	8 004779 023385

Sunny Line, safe and environmental friendly

Using the sun's energy in a natural way, SUNNY LINE solar showers produce free hot water: just like a solar panel, the tank base connected to the water mains and exposed to the sun for about 2 hours to heat the water contained in it up to over 60°. This, properly mixed with cold water through the mixer, makes it possible to deliver approximately **60 litres of water at 30°***.

The horizontal development of the base provides better exposure to sunlight compared to vertical development models. The tank base, constantly filled via the connection to the water mains, ensures stability and strength. The pressure regulator also ensures use in total safety.

*The figures vary depending on weather conditions and are calculated in ideal conditions.

"SUNNY NIAGARA" Solar shower

The Sunny NIAGARA solar shower exploits natural sunlight to produce hot water naturally and free of charge.

- Contemporary styling
- Ergonomic mixer that allows more precise temperature control and independent selection of flow rate and temperature.
- Height 2.10 m
- Larger tank base and 20 cm diameter shower head for increased flow rate.

Patented



GF80286908	
Box (LxWxH) cm 60x28x60	
Pcs 1	
Kg 9	8 004779 033995

GF80276908	
Box (LxWxH) cm 60x28x60	
Pcs 1	
Kg 9	8 004779 033988

GF80266908	
Box (LxWxH) cm 60x28x60	
Pcs 1	
Kg 9	8 004779 033971

GF80296908	
Box (LxWxH) cm 60x28x60	
Pcs 1	
Kg 9	8 004779 034008

“SUNNY STYLE PREMIUM” Solar shower

The “Sunny Style Premium” solar shower uses the energy from the sun’s ray to produce hot water ecologically and without using any electricity.

- hot and cold water mixer, to adjust the requested temperature
 - stable and safe tank/base
 - adjustable height from 1,40 to 2,10 m
 - extractible and adjustable shower hose
 - inlet pressure regulator with safety valve
 - plug&play kit equipped with 3/4” tap adaptor, 2 SOFT TOUCH hose connectors and 10 m of phthalates free hose for the tap connection.
- Patented

“SUNNY STYLE” Solar shower

The “Sunny Style” solar shower uses the energy from the sun’s ray to produce hot water ecologically and without using any electricity.

- hot and cold water mixer, to adjust the requested temperature
 - stable and safe tank/base
 - useful height 2 m
 - inlet pressure regulator with safety valve
 - 3/4” tap adaptor
- Patented

Sunny Style Premium



Sunny Style



DETACHABLE AND ADJUSTABLE SHOWER HEAD



ADJUSTABLE HEIGHT



MIXER



PRESSURE REGULATOR



ADJUSTABLE SHOWER HEAD



MIXER



PRESSURE REGULATOR



GF80005524	
Box (LxWxH) cm 60x23x60	
Pcs 1	
Kg 7,53	8 004779 019210

GF80005525	
Box (LxWxH) cm 60x23x60	
Pcs 1	
Kg 7,53	8 004779 019227

GF80005520	
Box (LxWxH) cm 60x23x60	
Pcs 1	
Kg 6,38	8 004779 019135

GF80005521	
Box (LxWxH) cm 60x23x60	
Pcs 1	
Kg 6,38	8 004779 019142

GF80005526	
Box (LxWxH) cm 60x23x60	
Pcs 1	
Kg 7,53	8 004779 019234

GF80005523	
Box (LxWxH) cm 60x23x60	
Pcs 1	
Kg 7,53	8 004779 019203

GF80005522	
Box (LxWxH) cm 60x23x60	
Pcs 1	
Kg 6,38	8 004779 019159

GF80005519	
Box (LxWxH) cm 60x23x60	
Pcs 1	
Kg 6,38	8 004779 018794



“MODO” Light Grey

Wall plant container with new and exclusive styling. The geometrical shape and clean lines are perfect for creating green features to bring nature into the home. The clear plastic housing holds the coloured container to protect the walls from soil, water and leaves. Removable container for easy maintenance. MODO is a modular and versatile décor accessory that can be hung on a wall or placed on a flat surface. Sold complete with potting compost.



“FOR” container bag

Container bag in soft plastic material. Multifunction for gardening, shopping, sea, living, and camping. Simple and functional, it is ideal for organizing and storing small items.

“For2” container bag

Container bag in soft plastic material. Multifunction for gardening, shopping, beach-going, living, and camping. Simple and functional, it is ideal for organizing and storing small and medium sized items.



“MODO” Light Grey

GF86010001	
Box (LxWxH) cm 28,5x26x26	
Pcs 2	
Kg 2,3	8 004779 034091



“MODO” Grey

GF86010002	
Box (LxWxH) cm 28,5x26x26	
Pcs 2	
Kg 2,3	8 004779 034107



“MODO” Dark Grey

GF86010003	
Box (LxWxH) cm 28,5x26x26	
Pcs 2	
Kg 2,3	8 004779 034121



GF80287602	
Box (LxWxH) cm 38x28x60	
Pcs 10	
Kg 3,2	8 004779 026133

GF80287606	
Box (LxWxH) cm 37x20x56	
Pcs 4	
Kg 2,4	8 004779 029738

GF80277602	
Box (LxWxH) cm 38x28x60	
Pcs 10	
Kg 3,2	8 004779 026126

GF80277606	
Box (LxWxH) cm 37x20x56	
Pcs 4	
Kg 2,4	8 004779 029721

GF80267602	
Box (LxWxH) cm 38x28x60	
Pcs 10	
Kg 3,2	8 004779 026119

GF80267606	
Box (LxWxH) cm 37x20x56	
Pcs 4	
Kg 2,4	8 004779 029714

GF80297602	
Box (LxWxH) cm 38x28x60	
Pcs 10	
Kg 3,2	8 004779 026140

GF80297606	
Box (LxWxH) cm 37x20x56	
Pcs 4	
Kg 2,4	8 004779 029745



Carton Display
"AQUABAG STYLE" color mix
 18 pz. (6 pz. fuxia, 6 pz. blue, 6 pz. lime)

GF80255628	
Box (LxWxH) cm 72x54x103	
In Store (LxWxH) cm 72x54x140	
Pcs 1	Kg 44

Carton Display
"AQUABAG MAXI" color mix
 12 pz. (4 pz. fuxia, 4 pz. blue, 4 pz. lime)

GF80255608	
Box (LxWxH) cm 72x54x115	
In Store (LxWxH) cm 72x54x160	
Pcs 1	Kg 49,5

Carton Display
"AQUAFLORA HOLIDAY" color mix 160 pz.

GF80250080		
Box (LxWxH) cm 82x42x63		
In Store (LxWxH) cm 79x40x143		
Kg 15	Pcs 160	EAN 8004779023330

Carton Display
"AQUAFLORA HOLIDAY TRIS" color mix 72 pz.

GF80250081		
Box (LxWxH) cm 82x42x63		
In Store (LxWxH) cm 79x40x143		
Kg 17,4	Pcs 72	EAN 8004779023385

MERCHANDISING



Carton Banner
"SUNNY STYLE"

GF21000609	
Box (LxWxH) cm 61x50x2,5	
Pcs 1	Kg 0,5



Carton Display
“SUNNY NIAGARA” color mix
4 pz. (1 pz. gray, 1 pz. lime,
1 pz. fuxia, 1 pz. blue)

GF80256909	
Box (LxWxH) cm 62x62x115 In Store (LxWxH) cm 62x62x171	
Pcs 1	Kg 43

Carton Display
“SUNNY NIAGARA” lime
4 pz. lime

GF80286909		
Box (LxWxH) cm 62x62x115 In Store (LxWxH) cm 62x62x171		
Kg 43	Pcs 4	EAN 8004779033995

Carton Display
“SUNNY NIAGARA” blue
4 pz. blue

GF80266909		
Box (LxWxH) cm 62x62x115 In Store (LxWxH) cm 62x62x171		
Kg 43	Pcs 4	EAN 8004779033971

Carton Display
“SUNNY NIAGARA” fuxia
4 pz. fuxia

GF80276909		
Box (LxWxH) cm 62x62x115 In Store (LxWxH) cm 62x62x171		
Kg 43	Pcs 4	EAN 8004779033988

Carton Display
“SUNNY NIAGARA” gray
4 pz. gray

GF80296909		
Box (LxWxH) cm 62x62x115 In Store (LxWxH) cm 62x62x171		
Kg 43	Pcs 4	EAN 8004779034008



Carton Display
“SUNNY STYLE” color mix
4 pz. (1 pz. gray, 1 pz. lime,
1 pz. fuxia, 1 pz. blue)

GF80005919	
Box (LxWxH) cm 62x62x95 In Store (LxWxH) cm 62x62x171	
Pcs 1	Kg 29,5

Carton Display
“SUNNY STYLE PREMIUM” lime
4 pz. lime

GF80176074		
Box (LxWxH) cm 62x62x95 In Store (LxWxH) cm 62x62x171		
Kg 33,7	Pcs 4	EAN 8004779019210

Carton Display
“SUNNY STYLE” lime
4 pz. lime

GF80176070		
Box (LxWxH) cm 62x62x95 In Store (LxWxH) cm 62x62x171		
Kg 29,5	Pcs 4	EAN 8004779019135

Carton Display
“SUNNY STYLE PREMIUM” fuxia
4 pz. fuxia

GF80176075		
Box (LxWxH) cm 62x62x95 In Store (LxWxH) cm 62x62x171		
Kg 33,7	Pcs 4	EAN 8004779019227

Carton Display
“SUNNY STYLE” fuxia
4 pz. fuxia

GF80176071		
Box (LxWxH) cm 62x62x95 In Store (LxWxH) cm 62x62x171		
Kg 29,5	Pcs 4	EAN 8004779019142

Carton Display
“SUNNY STYLE PREMIUM” blue
4 pz. blue

GF80176076		
Box (LxWxH) cm 62x62x95 In Store (LxWxH) cm 62x62x171		
Kg 33,7	Pcs 4	EAN 8004779019234

Carton Display
“SUNNY STYLE” blue
4 pz. blue

GF80176072		
Box (LxWxH) cm 62x62x95 In Store (LxWxH) cm 62x62x171		
Kg 29,5	Pcs 4	EAN 8004779019159

Carton Display
“SUNNY STYLE PREMIUM” color mix
4 pz. (1 pz. gray, 1 pz. lime,
1 pz. fuxia, 1 pz. blue)

GF80005918	
Box (LxWxH) cm 62x62x95 In Store (LxWxH) cm 62x62x171	
Pcs 1	Kg 33,7

Carton Display
“SUNNY STYLE PREMIUM” gray
4 pz. gray

GF80176073		
Box (LxWxH) cm 62x62x95 In Store (LxWxH) cm 62x62x171		
Kg 33,7	Pcs 4	EAN 8004779019203

Carton Display
“SUNNY STYLE” gray
4 pz. gray

GF80176069		
Box (LxWxH) cm 62x62x95 In Store (LxWxH) cm 62x62x171		
Kg 29,5	Pcs 4	EAN 8004779018794



AVAILABLE
WHILE
STOCK LAST

Carton Display
"AQUAPOP 15" mix color
20 pz. (6 pz. lime, 4 pz. fuxia, 6 pz. blue,
4 pz. gray)

GF80257651	
Box (LxWxH) cm 72x54x115 In Store (LxWxH) cm 72x54x160	
Pcs 1	Kg 31

Carton Display
"AQUAPOP 30" mix color
12 pz. (4 pz. lime, 2 pz. fuxia, 4 pz. blue,
2 pz. gray)

GF80257603	
Box (LxWxH) cm 72x54x115 In Store (LxWxH) cm 72x54x160	
Pcs 1	Kg 33

Carton Display
"AQUAGO Bunny 25" mix color
12 pz. (4 pz. cipria, 4 pz. avio,
2 pz. vinaccia, 2 pz. salvia)

GF80257657	
Box (LxWxH) cm 72x54x115 In Store (LxWxH) cm 72x54x160	
Pcs 1	Kg 34,5

Carton Display
"AQUABALCONY" mix color
24 pz. (6 pz. lime, 6 pz. fuxia,
6 pz. blue, 6 pz. gray)

GF80255852	
Box (LxWxH) cm 72x54x102,5 In Store (LxWxH) cm 72x54x140	
Pcs 1	Kg 37

MODO
il verde sempre in casa

aqualight
15 KIT

FOR
EVERYDAY



Carton Display
"MODO" mix color
18 pz. (6 pz. light gray, 6 pz. gray,
6 pz. dark gray)

GF86010000	
Box (LxWxH) cm 72x54x102,5 In Store (LxWxH) cm 72x54x140	
Pcs 1	Kg 29

Carton Display
"AQUALIGHT 15 KIT 5/8"
36 pz.

GF80287157		
Box (LxWxH) cm 80x60x115 In Store (LxWxH) cm 80x60x160		
Kg 65	Pcs 36	EAN 8004779038785

Carton Display "FOR" mix color
40 pz. (10 pz. lime, 10 pz. fuxia,
10 pz. blue, 10 pz. gray)

GF80257602	
Box (LxWxH) cm 72x54x102,5 In Store (LxWxH) cm 72x54x140	
Pcs 1	Kg 20

aqualight
15

aqualight
30

aquago™
easy15

aquago™
easy30

aquapop™
EASY
GREY

PRO
aquapop™
GREY



Carton Display
AQUALIGHT 15 m 5/8"
45 pz.

GF80170083		
Box (LxWxH) cm	82x60x115	
In Store (LxWxH) cm	80x60x160	
Kg	Pcs	EAN
70	45	8004779036156

Carton Display
AQUALIGHT 15 m 3/4"
30 pz.

AVAILABLE WHILE STOCK LAST

GF80170084		
Box (LxWxH) cm	82x60x115	
In Store (LxWxH) cm	80x60x160	
Kg	Pcs	EAN
63	30	8004779036170

Carton Display
AQUALIGHT 30 m 5/8"
25 pz.

GF80170085		
Box (LxWxH) cm	82x60x115	
In Store (LxWxH) cm	80x60x160	
Kg	Pcs	EAN
71	25	8004779036163

Carton Display
AQUAGO EASY 15 m
60 pz.

AVAILABLE WHILE STOCK LAST

GF80297648		
Box (LxWxH) cm	80x60x115	
In Store (LxWxH) cm	80x60x160	
Kg	Pcs	EAN
66	60	8004779037030

Carton Display
AQUALIGHT 30 m 3/4"
20 pz.

AVAILABLE WHILE STOCK LAST

GF80170089		
Box (LxWxH) cm	82x60x115	
In Store (LxWxH) cm	80x60x160	
Kg	Pcs	EAN
76	20	8004779036187

Carton Display
AQUAGO EASY 30 m
48 pz.

AVAILABLE WHILE STOCK LAST

GF80297649		
Box (LxWxH) cm	82x60x115	
In Store (LxWxH) cm	80x60x160	
Kg	Pcs	EAN
82	48	8004779037047

Carton Display - 72pz
"AQUAPOP GREY EASY 10m"

10m GF80297679		
Box (LxWxH) cm	80x60x115	
In Store (LxWxH) cm	80x60x160	
Kg	Pcs	EAN
80	72	8004779040108

Carton Display - 72pz
"AQUAPOP GREY EASY 15m"

15m GF80297680		
Box (LxWxH) cm	80x60x115	
In Store (LxWxH) cm	80x60x160	
Kg	Pcs	EAN
87	72	8004779040115

Carton Display - 48pz
"AQUAPOP GREY EASY 25m"

25m GF80297682		
Box (LxWxH) cm	80x60x115	
In Store (LxWxH) cm	80x60x160	
Kg	Pcs	EAN
90	48	8004779040139

Carton Display - 48pz
"AQUAPOP GREY EASY 30m"

30m GF80297683		
Box (LxWxH) cm	80x60x115	
In Store (LxWxH) cm	80x60x160	
Kg	Pcs	EAN
105	48	8004779040146

Carton Display - 24pz
"AQUAPOP GREY PRO 15m"

GF80287684		
Box (LxWxH) cm	80x60x115	
In Store (LxWxH) cm	80x60x160	
Kg	Pcs	EAN
45	24	8004779040153

Carton Display - 24pz
"AQUAPOP GREY PRO 25m"

GF80287685		
Box (LxWxH) cm	80x60x115	
In Store (LxWxH) cm	80x60x160	
Kg	Pcs	EAN
73	24	8004779040160

aquapop™
GREY



Carton Display - 18pz
"AQUAPOP GREY 25"

GF80297687		
Box (LxWxH) cm	80x60x115	
In Store (LxWxH) cm	80x60x160	
Kg	Pcs	EAN
56	18	8004779040306

WE ARE GREEN

+70%
RECYCLED
PLASTIC

GREEN

WE ARE GREEN

**The first irrigation range,
with over 70% recycled plastic**

REUSE, REDUCE, RECYCLE,

the new approach of G.F. engendered in the RECO range.

A range made with more than 70% of recycled plastic, a range that is rigorously Made in Italy. A new production chain cycle, more attentive to sustainability and CO2 emissions. A new Mission, a future-oriented Vision, because correct irrigation practices must start from respect for the environment. **We are green.**

REUSE

Give plastic a second lease of life

The Circular Economy concept can be applied also and above all to the plastic production chain. In recent times the use of this raw material in the manufacturing sector has been rising steadily, although recycling practices are unable to keep up. This is the background to the birth of the RECO range.

Reuse - The irrigation articles of the RECO range are made of post-consumer polypropylene (e.g. sourced from domestic sorted waste collection nationwide) and not all: also material taken from industrial scrap produced by companies operating in a range of different sectors (medical, building construction, automotive and many more besides).

The system therefore considers not merely the industrial process, but also the waste produced by end consumers, thus making the production process as complete as possible and with the greatest potential for positive impact.

Recycle - thanks to the replacement of conventional plastics with sustainable materials, **more than 70% of the RECO range is made from recycled plastics. The process adopted allows G.F. to take what is deemed to be a waste product and give it a New Lease of Life: from waste to new resource.**



ENVIRONMENT

Reduce emissions

We must take care not to forget the impact on climate: processes of transformation and use of raw materials produce a major impact on the environment and an increase in CO2 emissions. More rational use can reduce the production of carbon dioxide and help to improve the health of the environment.

Reduce - with the aim of reducing both CO2 emissions and those released by the use of fossil fuels, thus reducing the negative footprint of the production process, products in the RECO range are made using ABS sourced from G.F.'s own industrial scrap. After suitable reprocessing, the ABS is transformed into a reusable raw material. **This system allows G.F. to maintain a more sustainable supply chain with reduced CO2 emissions: each product in the RECO range allows a saving of more than 50%* in CO2 emissions compared to an equivalent product from the conventional range.**

(* Average, non-contractual data that may vary in accordance with external factors.

FIRST IN THE GARDEN SECTOR

Unconventional innovation

G.F. has always been committed to the continual development of the quality of products and of a range that is increasingly aligned with market needs and demands. That's why G.F. is the first player in the irrigation accessories sector to develop a range made from renewable sources.

RECO is the first range of irrigation accessories composed of more than 70% recycled plastic.

A complete, essential and intuitive range. A line that accepts no compromise: the maximum G.F. quality, combined with respect for the environment.





G.F. PRODUCTION CHAIN CYCLE

SUPPLY CHAIN AND PRODUCTION

Thanks to the Procurement, R&D, and Quality departments, and thanks also to its ultra-modern production plants, G.F. can guarantee highly attentive selection of resources and close control of each stage in the production process, from incoming raw materials to final assembly. **All this, combined with constant monitoring and assessment of all suppliers, allows us to work exclusively with safe and certified partners.**

G.F. Produit RECO
 Manufactures RECO / Produit RECO
 Fertigung von RECO / Produce RECO
 A G.F. produz RECO

+70% RICICLATA
 recycled - recyclée
 recycelt - reciclada





Threaded tap connector

- Internal screw thread for tap
- Grabbing surface
- Male connection to connect to the hose terminal



Dual outlet tap connector

Dual outlet tap connector with differentiated water flow adjustment. Flow-rate regulator-modulator for each outlet to adjust separately the flow rate until the total closing. Useful for coupling more accessories simultaneously.



“OPEN” hose connector

For click-fitting the hose to the tap connector. Uninterrupted water passage.



Repair connector

For repairing damaged hoses or joining two hoses.

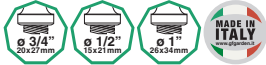

GF80605414	
Box (LxWxH) cm 20,7x14,7x10,4	
Pcs 10	
Kg 0,44	8 004779 035692



GF80605073	
Box (LxWxH) cm 37,5x25,5x15,5	
Pcs 8	
Kg 1,49	8 004779 035807



GF80605808	
Box (LxWxH) cm 20,7x14,7x10,4	
Pcs 10	
Kg 0,46	8 004779 035715



GF80605819	
Box (LxWxH) cm 22,7x15,2x15,4	
Pcs 10	
Kg 0,66	8 004779 038969

GF80603414	
Box (LxWxH) cm 12x46x15	
Pcs 75	
Kg 2,07	8 004779 035685

GF80603073	
Box (LxWxH) cm 24x46x15	
Pcs 10	
Kg 1,51	8 004779 035791

GF80603808	
Box (LxWxH) cm 24x46x15	
Pcs 50	
Kg 1,57	8 004779 035067

GF80603819	
Box (LxWxH) cm 12x46x15	
Pcs 25	
Kg 1,33	8 004779 038952



“ACQUASTOP” hose connector

For click-fitting the hose to various irrigation accessories. Automatic water stop-valve.



“OPEN” hose connector

For click-fitting the hose to the tap connector. Uninterrupted water passage.



“ACQUASTOP” hose connector

For click-fitting the hose to various irrigation accessories. Automatic water stop-valve.



Repair connector

For repairing damaged hoses or joining two hoses.



GF80605809	
Box (LxWxH) cm 20,7x14,7x10,4	
Pcs 10	
Kg 0,48	8 004779 035722



GF80605817	
Box (LxWxH) cm 22,7x15,2x15,4	
Pcs 10	
Kg 0,66	8 004779 038921



GF80605818	
Box (LxWxH) cm 22,7x15,2x15,4	
Pcs 10	
Kg 0,66	8 004779 038945



GF80605816	
Box (LxWxH) cm 22,7x15,2x15,4	
Pcs 10	
Kg 0,66	8 004779 038433

GF80603809	
Box (LxWxH) cm 12x46x15	
Pcs 25	
Kg 0,87	8 004779 035074

GF80603817	
Box (LxWxH) cm 12x46x15	
Pcs 25	
Kg 1,33	8 004779 038914

GF80603818	
Box (LxWxH) cm 12x46x15	
Pcs 25	
Kg 1,33	8 004779 038938

GF80603816	
Box (LxWxH) cm 12x46x15	
Pcs 25	
Kg 1,33	8 004779 038440



Two-way connector

For interconnecting TWO hose lines equipped with snap-fit hose connectors.



Three-way connector

For interconnecting THREE hose lines equipped with snap-fit hose connectors.



Threaded adaptor connector with male junction.

Allows hoses equipped with click connectors to be linked with irrigators having a female threaded inlet of 3/4" gas (ø 20-27 mm).



GF80605450	
Box (LxWxH) cm 14,5x14,5x11	
Pcs 10	
Kg 0,25	8 004779 035814



GF80605451	
Box (LxWxH) cm 14,5x14,5x11	
Pcs 10	
Kg 0,31	8 004779 035821



GF80605429	
Box (LxWxH) cm 14,5x14,5x11	
Pcs 10	
Kg 0,22	8 004779 035708

GF80603450	
Box (LxWxH) cm 12x46x15	
Pcs 75	
Kg 0,80	8 004779 035081

GF80603451	
Box (LxWxH) cm 12x46x15	
Pcs 75	
Kg 1,25	8 004779 035098

GF80603429	
Box (LxWxH) cm 12x46x15	
Pcs 75	
Kg 0,59	8 004779 035104





Medium size spray nozzle

- Jet adjustment from fine spray cone to direct jet
- Maximum flow 14 l/min at 4 bar



Medium size spray nozzle kit

- Spray nozzle medium size
- 3/4", 1/2" and 1" tap connector
- "OPEN" and "ACQUASTOP" 1/2"-5/8" hose connectors



Watering gun "3 JET Easy"

- Flow rate regulator-modulator for progressive regulation of water flow from off to max
- "3 JET" selector: fixed, fan and cone jet
- Max. flow rate 18 l/min. at 4 bar



Multi-jet watering gun "8 JET Easy"

- Flow rate regulator-modulator for progressive regulation of water flow from off to max
- "8 JET" rotary selector to choose from 8 different jets
- Max. flow rate 18 l/min. at 4 bar



GF80605400	
Box (LxWxH) cm	29,7x24,2x11,4
Pcs	10
Kg	0,74
8 004779 035838	

GF80603400	
Box (LxWxH) cm	24x46x15
Pcs	40
Kg	2,11
8 004779 035111	



GF80606917	
Box (LxWxH) cm	37,5x25,5x15,5
Pcs	10
Kg	2,22
8 004779 038419	

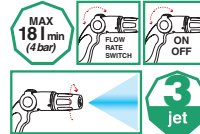

GF80605537	
Box (LxWxH) cm	36x21,7x12
Pcs	8
Kg	1,14
8 004779 035869	

GF80603537	
Box (LxWxH) cm	24x46x15
Pcs	20
Kg	2,25
8 004779 035852	

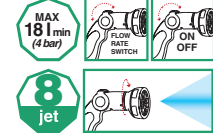

GF80606912	
Box (LxWxH) cm	36x21,7x12
Pcs	8
Kg	1,30
8 004779 035876	

GF80603912	
Box (LxWxH) cm	24x46x15
Pcs	16
Kg	2,07
8 004779 035128	





"8 JET Easy" watering gun Kit

- "8 JET Easy" watering gun
- 3/4", 1/2" and 1" tap connector
- "OPEN" and "ACQUASTOP" 1/2"-5/8" hose connectors



Medium flow rate watering gun "3 JET"

- Flow rate regulator-modulator with soft non-slip rubber covering
- Front lever with locking device
- "3-JET" selector: fixed, fan and cone jet
- Max. flow rate 20 l/min at 4 bar



Medium flow rate watering gun "8 JET"

- Flow rate regulator-modulator with soft non-slip rubber covering
- Front lever with locking device
- Circular "8 JET" selector with ergonomic rubber rim to promote grip and maximise ease of use
- Inspectable micro-perforated disk for possible periodic maintenance requirements
- 20 l/min maximum flow rate at 4 bar



Medium flow rate watering gun "8 JET" Kit

- Medium flow rate watering gun "8 JET"
- 3/4", 1/2" and 1" tap connector
- "OPEN" and "ACQUASTOP" 1/2"-5/8" hose connectors



GF80606918	
Box (LxWxH) cm 37,5x25,5x15,5	
Pcs 6	8 004779 038426
Kg 1,72	

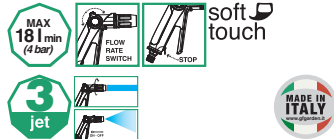

GF80606903	
Box (LxWxH) cm 36x21,7x12	
Pcs 8	8 004779 037825
Kg 1,30	

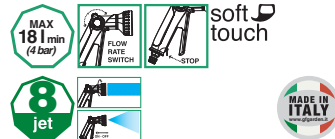

GF80606905	
Box (LxWxH) cm 36x21,7x12	
Pcs 8	8 004779 037801
Kg 1,50	

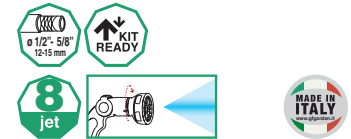

GF80606921	
Box (LxWxH) cm 37,5x25,5x15,5	
Pcs 6	8 004779 038808
Kg 1,75	

GF80603903	
Box (LxWxH) cm 24x46x15	
Pcs 20	8 004779 037832
Kg 2,86	

GF80603905	
Box (LxWxH) cm 24x46x15	
Pcs 16	8 004779 037818
Kg 2,66	



"XL Selector" spray watering gun 5JET, with +70% recycled plastic

- Large selector (ø 9cm) with ergonomic rubber
- 5 different spray patterns, including a wide shower spray and an perlator (air-mixed spray), suitable for delicate plants and flowers, even in pots.
- Flow rate regulator-modulator with soft non-slip rubber covering
- Front lever with locking device
- 20 l/min maximum flow rate at 4 bar

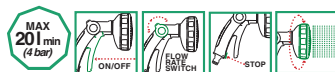

GF80606937	
Box (LxWxH) cm 36x21,7x12	
Pcs 4	8 004779 044205
Kg 1,12	

GF80603937	
Box (LxWxH) cm 46x24x15	
Pcs 8	8 004779 044212
Kg 1,96	



Multi-jet watering wand with adjustable head

- Ideal for watering hard-to-reach places such as flower beds, vases and hanging baskets.
- 8 different jet types
- Tap for micro-adjustment of flow
- Adjustable joint
- Maximum flow 16 l/min at 4 bar

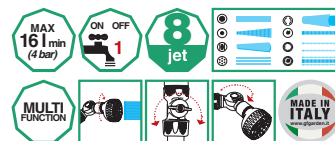

GF80605448	
Box (LxWxH) cm 78,4x14,4x13,4	
Pcs 4	8 004779 035999
Kg 1,07	



“CONO” sprinkler

Static sprinkler for small areas and when a very gentle and fine jet is required. Stake version.

- Maximum flow 23 l/min



“ROTAX” sprinkler

Ideal for watering medium-small areas. Stake version.

- Adjustable nozzles to optimise the watering depending on the type of plants
- Maximum flow 19 l/min.



“ROTAX” sprinkler

Ideal for watering medium-small areas.

- Adjustable nozzles to optimise the watering depending on the type of plants
- Maximum flow 19 l/min.

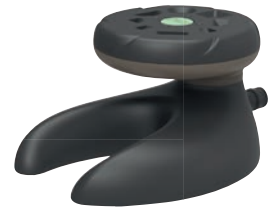

“DRIVER” sprinkler

Multi-purpose circular sprinkler with base. Simply rotate the disc to control watering of 8 different areas.

- Maximum flow rate 18 l/min



GF80605619	
Box (LxWxH) cm 37,5x25,5x15,5	
Pcs 8	
Kg 0,86	8 004779 035937



GF80605633	
Box (LxWxH) cm 37,5x25,5x15,5	
Pcs 8	
Kg 0,99	8 004779 035920



GF80605632	
Box (LxWxH) cm 37,5x25,5x15,5	
Pcs 8	
Kg 1,28	8 004779 035890

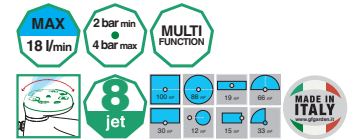

GF80605617	
Box (LxWxH) cm 37,5x25,5x15,5	
Pcs 4	
Kg 1,28	8 004779 035913

GF80603619	
Box (LxWxH) cm 24x46x15	
Pcs 12	
Kg 0,87	8 004779 035159

GF80603633	
Box (LxWxH) cm 24x46x15	
Pcs 12	
Kg 1,07	8 004779 035142

GF80603632	
Box (LxWxH) cm 24x46x15	
Pcs 6	
Kg 0,83	8 004779 035135

GF80603617	
Box (LxWxH) cm 24x46x15	
Pcs 4	
Kg 1,07	8 004779 035906



“Super rotax” rotating sprinkler

With two rotating arms with twin adjustment, for uniform watering of large and medium areas.

- Nozzles and arms separately adjustable
- Watering area from 30 to 160 sqm.
- Base of remarkable stability
- Maximum flow 15 l/min



Astral 4” oscillator

Oscillating sprinkler with continuously variable watering arc from 20° to 100°.

- Very quiet, it provides various watering possibilities, ideal for uniformly covering either small or large rectangular areas.
- plastic oscillating arm with 16 nozzles
 - pin for cleaning the holes
 - maximum flow 15 l/min

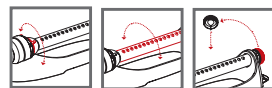

GF80605615	
Box (LxWxH) cm 39x28,5x27	
Pcs 6	
Kg 1,46	8 004779 035944



GF80605669	
Box (LxWxH) cm 40x28x21	
Pcs 6	
Kg 2,52	8 004779 037771

Wall hosepipe holder

For fixing to the wall to support the roll of hosepipe.



GF80607040	
Box (LxWxH) cm 38,5x29x30	
Pcs 8	
Kg 2,36	8 004779 035173



“BABY” portable

- Capacity 20 m of 1/2" hosepipe
- Complete with click connector

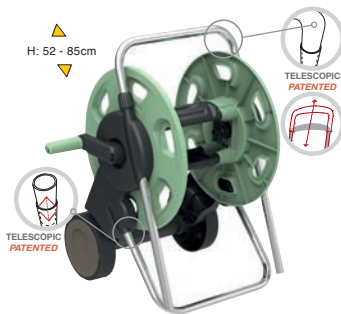

“CONCEPT” trolley

- Plastic and metal hose reel trolley
- Retractable telescopic handle
- Capacity max 60 m of 1/2" hose
- Complete with 2 “OPEN” 1/2"-5/8" hose click connectors



GF80605704	
Box (LxWxH) cm 29x15,5x29	
Pcs 1	
Kg 1,10	8 004779 035166



GF80605795	
Box (LxWxH) cm 38,5x14,5x55	
Pcs 1	
Kg 2,50	8 004779 035951



“BABY READY” portable hose reel with 75% recycled hose

- 15 m of Ø 1/2" hose
- 1 x Medium size spray nozzle
- 1 x hose connector 1/2"-5/8"
- 1 x Tap adaptor 3/4"

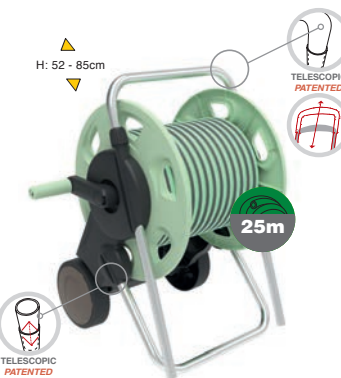

“CONCEPT READY 25” trolley hose reel with 75% recycled hose

- Plastic and metal hose trolley
- Retractable telescopic handle
- 25m of Ø 5/8" hose
- 1 x Medium flow rate watering gun “8 JET”
- 4 x hose connector 1/2"-5/8"
- 1 x Tap adaptor 3/4"



GF80605846	
Box (LxWxH) cm 29x26x29	
Pcs 1	
Kg 2,60	8 004779 040016



GF80605749	
Box (LxWxH) cm 80x120x55	
Pcs 6	
Kg 32	8 004779 035968

GF80605873	
Box (LxWxH) cm 80x120x30	
Pcs 12	
Kg 30	8 004779 040023

“AQUABAG” Mini hose reel

The new mini version hose reel is ideal for watering plants, flowers and pots on patios, balconies, verandas and small gardens. Thanks to its dual purpose design — floor standing or portable — this is a product that proves highly practical when in use, by virtue of being compact and lightweight, and with its new attractive styling, makes leisure time in the open air even more enjoyable.

- 10 meters of braided flexible hose (8,5 m rewinding inside + 1,5 m outside)
- 2 hose connectors
- medium size adjustable nozzle
- 3/4" tap connector



10m

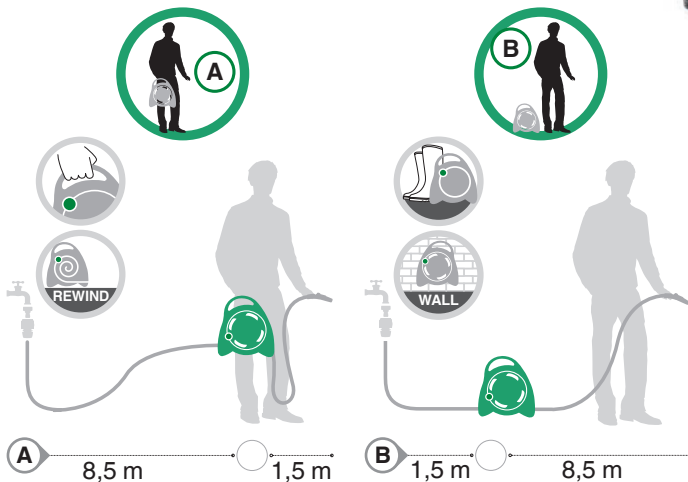

GF80605606	
Box (LxWxH) cm 35x30x32	
	Pcs 2
Kg 4,05	

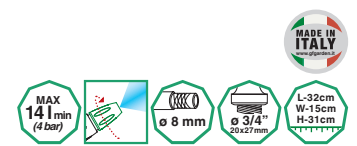

aquaflora holiday

Stand-alone drip watering system for pot plants.

- **SIMPLICITY:** to start watering, just attach a plastic bottle filled with water to the spike, pierce a small hole in the upturned bottom so that air can escape, then push the spike into the soil and adjust the flow of water as required.
- **STEADY AND MEASURED RELEASE OF WATER:** plants are watered by constant drip irrigation, ensuring that there can be no harmful waterlogging of the roots; the release of water from the bottle is adjusted with a handy tap positioned on the front of the spike.
- **EFFECTIVE WATERING:** the Aquaflora Holiday incorporates a special outlet grille that delivers each successive drip directly to the roots, avoiding waste and evaporation of the water and ensuring that the plant will stay in perfect health.

UNIVERSAL FITTING FOR PLASTIC BOTTLES OF 0.5 UP TO 2 LITRES

FLOW RATE ADJUSTER

CONSTANT DRIP WATERING DELIVERED DIRECT TO PLANT ROOTS



GF80606343	
Box (LxWxH) cm 38,5x29x30	
	Pcs 24
Kg 2,00	

Kit 20

Drip irrigation kit ideal for balconies, patios, flower beds and small gardens. Up to 20 containers/zones.

Contains:

- 1 Pressure reducer (from 3/3.5 to 1/1.2 bar)
- 1 Tap connector 3/4" (20-27 mm)
- 20 m Capillary hose 4x6
- 20 Capillary hose stakes
- 20 In line adjustable drippers (0-8 l/h; 1.5 bar)
- 3 In line taps
- 5 Straight connectors
- 10 Elbow connectors
- 10 T connectors
- 20 End of line plugs



GF80606163	
Box (LxWxH) cm 28x6,2x30,5	
Pcs 1	
Kg 0,90	8 004779 038327



1x
20 m (ø4x6)



AQUATIME DUE.5

"EASY BALCONY" FUNCTION

Ideal for irrigating potted plants and hedges, this function produces a daily cycle of: 6 hours of irrigation (1 minute every hour) - STOP for 6 hours - 6 hours of irrigation (1 minute every hour) - STOP for 6 hours.



25 programs



6" - 12" 24" - 48" 72" h. 1
1" - 3" 5" - 20" 45'



Kit 20 Due.5

Drip irrigation kit ideal for balconies, patios, flower beds and small gardens. Complete with irrigation programmer.

Up to 20 containers/zones. Contains:

- 1 irrigation programmer
- 1 Pressure reducer (from 3/3.5 to 1/1.2 bar)
- 1 Tap connector 3/4" (20-27 mm)
- 20 m Capillary hose 4x6
- 20 Capillary hose stakes
- 20 In line adjustable drippers (0-8 l/h; 1.5 bar)
- 3 In line taps
- 5 Straight connectors
- 10 Elbow connectors
- 10 T connectors
- 20 End of line plugs



1x
20 m (ø4x6)



GF80606162	
Box (LxWxH) cm 20x11x24	
Pcs 1	
Kg 1,10	8 004779 038310

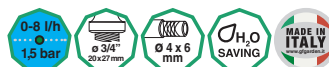



sunny
the solar shower

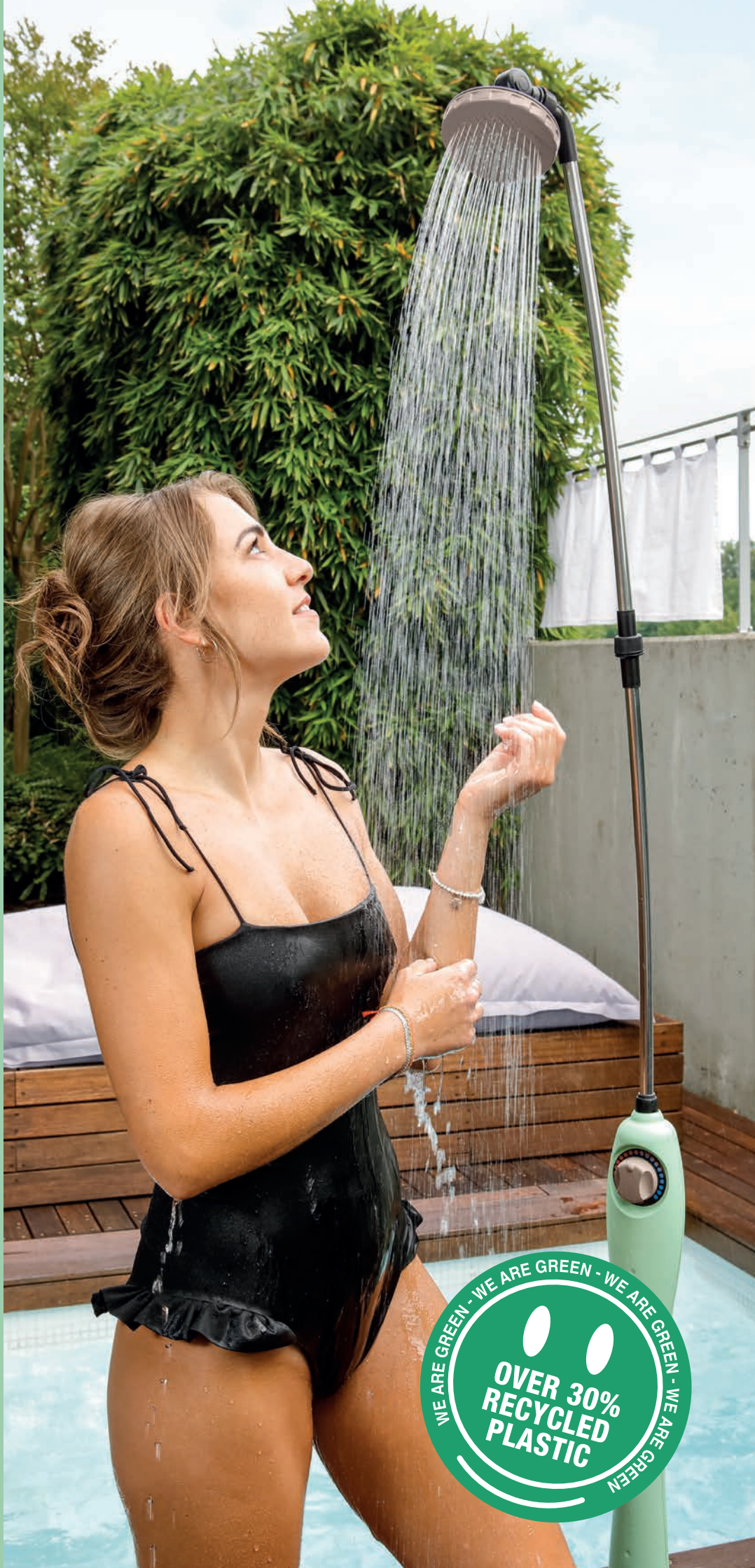

WE ARE GREEN - WE ARE GREEN - WE ARE GREEN - WE ARE GREEN
OVER 30%
RECYCLED
PLASTIC

RECYCLED AND ECOLOGICAL

The **SUNNY STYLE RECO** solar shower is made using over 30% recycled plastic: the shell in particular is made up of about 90% recycled PET from post-consumer plastic. It is also ecological, producing hot water by exploiting the energy of the sun's rays in a natural way. By connecting the tank base to the water supply and exposing it to the sun for about 2 hours, the water contained in it is heated to over 60°. This, suitably mixed with cold water using the mixer, allows about 60 litres of water at 30° C* to be distributed.

PRACTICAL: Light and handy, suitable for any outdoor environment, from the garden to the terrace to the swimming pool, even for lovers of motorhomes and camping.

SAFE AND EFFECTIVE: The horizontal development of the base guarantees better exposure to sunlight than vertical models: this means greater thermal efficiency as well as greater speed in the heating phases during the day. It is also fitted with an inlet pressure regulator with safety valve.

* Data varies according to the weather and are calculated under the best conditions.



GF80606919	
Box (LxWxH) cm 60x23x60	
Pcs 1	
Kg 7,50	8 004779 038334

Sunny Style RECO

The "Sunny Style RECO" solar shower is sold complete with:

- Hot and cold water mixer, to adjust the desired temperature
- Stable and safe base/tank
- Useful height 2 m
- Inlet pressure regulator with safety valve
- Adjustable shower head ø 12.5 cm



GF80605770	
Box (LxWxH) cm 40x16x40	
Pcs 1	
Kg 2,86	8 004779 037764

"SACK TROLLEY" collecting trolley

Light and manoeuvrable, the trolley is very practical for collecting grass, foliage and any other Indoor and Outdoor garden waste. The most popular spare sacks of 100 l. could be used with it.

HOSE BY USING 75% RECYCLED PVC

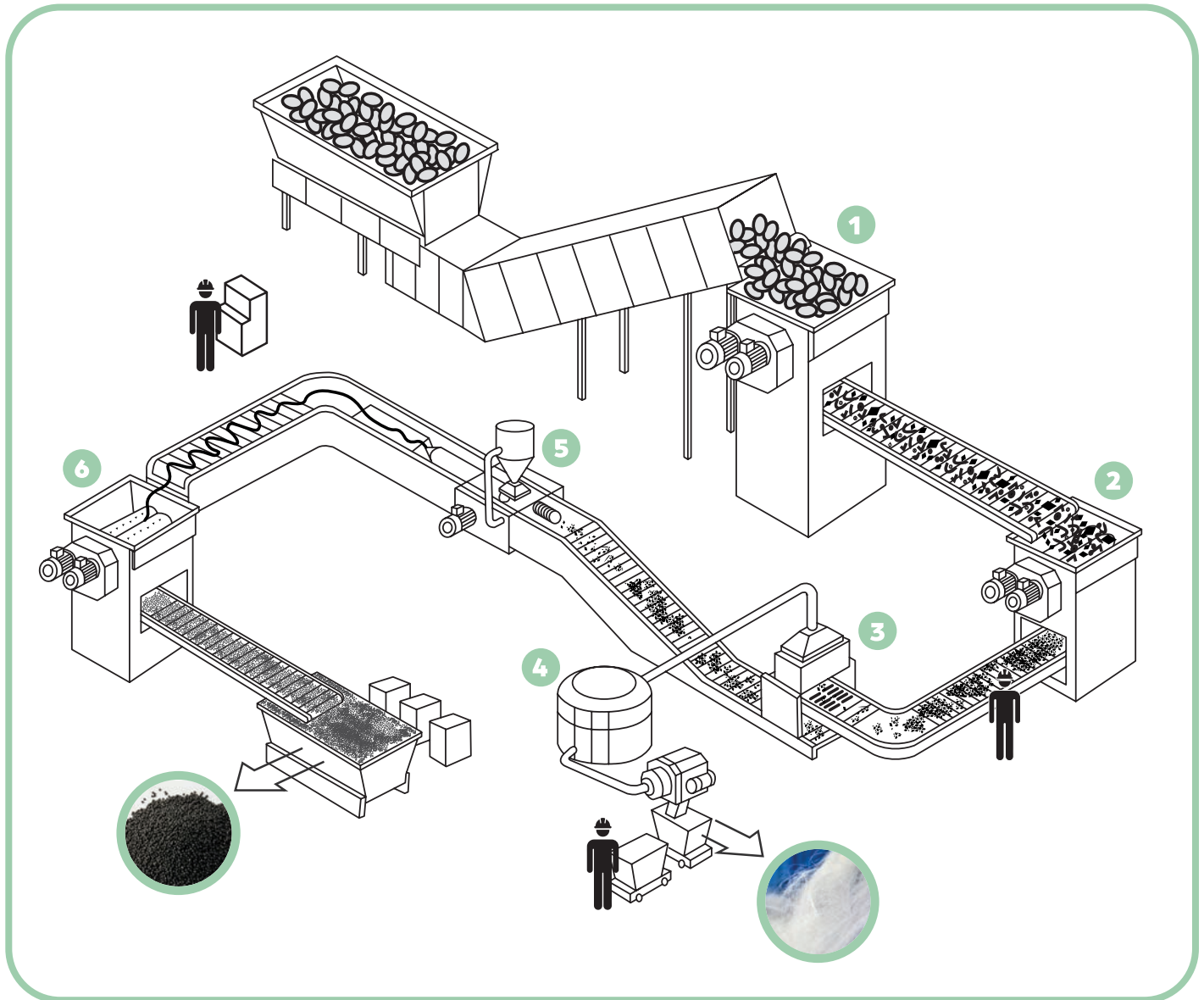

CUTTING
CRUSHING
SIEVING
FIBER SEPARATION
MIXING DYE AND EXTRUSION
CUTTING

STEP A (1, 2)

The waste hoses are cut (1) and then crushed into small pieces of a few centimeters through shredders (2).

STEP B (3,4)

Then these small pieces pass through sieve systems (3) to separate the fiber from the PVC (4). This PVC residue is called "the semolina". We need to separate the fibers that comes from textile reinforcement from our hoses to improve the pressure resistance of our final products.

STEP C (5,6)

This semolina is mixed (5) with black colorant and processed in an extruder (around 150°/160°C) and then cut again into small granulates (6) ready to be used again in our hoses. This fiber separator system was developed only for this line.

15

Anni di garanzia
Years guarantee
Ans de garantie
Jahren Garantie
Años de garantía

WE ARE GREEN

TNT Tricoflex Non Torsion that avoids kinks and twists ensuring a constant water flow. Soft Touch external surface that improves the grip of the product during use in the garden, resistance to abrasion on rough surfaces. It is not produced with contaminating elements (Cadmium, Barium and Lead); UV resistance and anti algae.

Foamed Technology makes an Ultramemory structure that always returns to its original shape without undergoing deformations, making the hose lighter, softer and more performing.

More and more RECO Using resources in a sustainable way is an absolute necessity in the modern world. The new line of GF recycled hoses enlarges the RECO recycled range: the first range of irrigation accessories, produced with more than 70% recycled plastic. Packagings are made of sustainable sourced cardboard. A future-oriented mission, because correct irrigation practices must start from respect for the environment.

We are green.





Ø 1/2
12,5 mm

Ø 5/8
15 mm

Ø 3/4
19 mm

15 m	GF80607300
(LxWxH) cm Ø 32x11	
Pcs 1	kg 2

15 m	GF80607303
(LxWxH) cm Ø 38x9,5	
Pcs 1	kg 2,3

15 m	GF80607306
(LxWxH) cm Ø 37x13,5	
Pcs 1	kg 3,4

PALLET		
Pcs	Box (LxWxH) cm	Kg
72	80x120x114	169

PALLET		
Pcs	Box (LxWxH) cm	Kg
60	80x120x111	163

PALLET		
Pcs	Box (LxWxH) cm	Kg
42	80x120x110	168

25 m	GF80607301
(LxWxH) cm Ø 37x12,5	
Pcs 1	kg 3,4

25 m	GF80607304
(LxWxH) cm Ø 36x12	
Pcs 1	kg 3,8

25 m	GF80607307
(LxWxH) cm Ø 37x20	
Pcs 1	kg 5,6

PALLET		
Pcs	Box (LxWxH) cm	Kg
48	80x120x115	188

PALLET		
Pcs	Box (LxWxH) cm	Kg
42	80x120x111	184

PALLET		
Pcs	Box (LxWxH) cm	Kg
30	80x120x115	193

50 m	GF80607302
(LxWxH) cm Ø 38x20	
Pcs 1	kg 6,7

50 m	GF80607305
(LxWxH) cm Ø 40x22	
Pcs 1	kg 7,5

50 m	GF80607308
(LxWxH) cm Ø 49x21	
Pcs 1	kg 11

PALLET		
Pcs	Box (LxWxH) cm	Kg
30	80x120x115	226

PALLET		
Pcs	Box (LxWxH) cm	Kg
24	80x120x103	205

PALLET		
Pcs	Box (LxWxH) cm	Kg
20	120x120x99	245

Kit with accessories RECO: +70% recycled plastic



15 m	GF80607309
(LxWxH) cm Ø 32x11	
Pcs 1	kg 2,1

15 m	GF80607311
(LxWxH) cm Ø 38x9,5	
Pcs 1	kg 2,5

15 m	GF80607313
(LxWxH) cm Ø 37x13,5	
Pcs 1	kg 3,6

PALLET		
Pcs	Box (LxWxH) cm	Kg
72	80x120x114	180

PALLET		
Pcs	Box (LxWxH) cm	Kg
60	80x120x111	172

PALLET		
Pcs	Box (LxWxH) cm	Kg
42	80x120x110	174

25 m	GF80607310
(LxWxH) cm Ø 37x12,5	
Pcs 1	kg 3,6

25 m	GF80607312
(LxWxH) cm Ø 36x12	
Pcs 1	kg 4

25 m	GF80607314
(LxWxH) cm Ø 37x20	
Pcs 1	kg 5,7

PALLET		
Pcs	Box (LxWxH) cm	Kg
48	80x120x115	196

PALLET		
Pcs	Box (LxWxH) cm	Kg
42	80x120x111	191

PALLET		
Pcs	Box (LxWxH) cm	Kg
30	80x120x115	198



Ready kit made with + 70% recycled plastic:
 • 1x open connector • 1x connector Acquastop • 1x tap connector 3/4+1/2 • 1x ergonomic nozzle 3 jet

Hoses pipe and kit sizes: a tolerance +/- 15mm to be considered



Ø 1/2
12,5 mm

Ø 5/8
15 mm

Ø 3/4
19 mm

15 m		GF80287300	
(LxWxH) cm Ø 32x11			
Pcs 1	kg 2	8 004779 040030	

PALLET		
Pcs	Box (LxWxH) cm	Kg
72	80x120x114	169

15 m		GF80287303	
(LxWxH) cm Ø 38x9,5			
Pcs 1	kg 2,3	8 004779 040467	

PALLET		
Pcs	Box (LxWxH) cm	Kg
60	80x120x111	163

15 m		GF80287306	
(LxWxH) cm Ø 37x13,5			
Pcs 1	kg 3,4	8 004779 040498	

PALLET		
Pcs	Box (LxWxH) cm	Kg
42	80x120x110	168

25 m		GF80287301	
(LxWxH) cm Ø 37x12,5			
Pcs 1	kg 3,4	8 004779 040443	

PALLET		
Pcs	Box (LxWxH) cm	Kg
48	80x120x115	188

25 m		GF80287304	
(LxWxH) cm Ø 36x12			
Pcs 1	kg 3,8	8 004779 040474	

PALLET		
Pcs	Box (LxWxH) cm	Kg
42	80x120x111	184

25 m		GF80287307	
(LxWxH) cm Ø 37x20			
Pcs 1	kg 5,6	8 004779 040504	

PALLET		
Pcs	Box (LxWxH) cm	Kg
30	80x120x115	193

50 m		GF80287302	
(LxWxH) cm Ø 38x20			
Pcs 1	kg 6,7	8 004779 040450	

PALLET		
Pcs	Box (LxWxH) cm	Kg
30	80x120x115	226

50 m		GF80287305	
(LxWxH) cm Ø 40x22			
Pcs 1	kg 7,5	8 004779 040481	

PALLET		
Pcs	Box (LxWxH) cm	Kg
24	80x120x103	205

50 m		GF80287308	
(LxWxH) cm Ø 49x21			
Pcs 1	kg 11	8 004779 040511	

PALLET		
Pcs	Box (LxWxH) cm	Kg
20	120x120x99	245

Kit with accessories RECO: +70% recycled plastic

15 m		GF80287309	
(LxWxH) cm Ø 32x11			
Pcs 1	kg 2,1	8 004779 040528	

PALLET		
Pcs	Box (LxWxH) cm	Kg
72	80x120x114	180

15 m		GF80287311	
(LxWxH) cm Ø 38x9,5			
Pcs 1	kg 2,5	8 004779 040542	

PALLET		
Pcs	Box (LxWxH) cm	Kg
60	80x120x111	172

15 m		GF80287313	
(LxWxH) cm Ø 37x13,5			
Pcs 1	kg 3,5	8 004779 040566	

PALLET		
Pcs	Box (LxWxH) cm	Kg
42	80x120x110	174

25 m		GF80287310	
(LxWxH) cm Ø 37x12,5			
Pcs 1	kg 3,6	8 004779 040535	

PALLET		
Pcs	Box (LxWxH) cm	Kg
48	80x120x115	196

25 m		GF80287312	
(LxWxH) cm Ø 36x12			
Pcs 1	kg 4	8 004779 040559	

PALLET		
Pcs	Box (LxWxH) cm	Kg
42	80x120x111	191

25 m		GF80287314	
(LxWxH) cm Ø 37x20			
Pcs 1	kg 5,7	8 004779 040573	

PALLET		
Pcs	Box (LxWxH) cm	Kg
30	80x120x115	198



Ready kit made with + 70% recycled plastic:

- 1x open connector • 1x connector Acquastop • 1x tap connector 3/4+1/2 • 1x ergonomic nozzle 3 jet

Hoses pipe and kit sizes: a tolerance +/- 15mm to be considered





Ø 1/2
12,5 mm

Ø 5/8
15 mm

Ø 3/4
19 mm

15 m		GF80277300	
(LxWxH) cm Ø 32x11			
Pcs 1	kg 2	8 004779 040580	

PALLET		
Pcs	Box (LxWxH) cm	Kg
72	80x120x114	169

15 m		GF80277303	
(LxWxH) cm Ø 38x9,5			
Pcs 1	kg 2,3	8 004779 040603	

PALLET		
Pcs	Box (LxWxH) cm	Kg
60	80x120x111	163

25 m		GF80277301	
(LxWxH) cm Ø 37x12,5			
Pcs 1	kg 3,4	8 004779 040597	

PALLET		
Pcs	Box (LxWxH) cm	Kg
48	80x120x115	188

25 m		GF80277304	
(LxWxH) cm Ø 36x12			
Pcs 1	kg 3,8	8 004779 040610	

PALLET		
Pcs	Box (LxWxH) cm	Kg
42	80x120x111	184

Kit with accessories RECO: +70% recycled plastic



15 m		GF80277309	
(LxWxH) cm Ø 32x11			
Pcs 1	kg 2,1	8 004779 040627	

PALLET		
Pcs	Box (LxWxH) cm	Kg
72	80x120x114	180

15 m		GF80277311	
(LxWxH) cm Ø 38x9,5			
Pcs 1	kg 2,5	8 004779 040658	

PALLET		
Pcs	Box (LxWxH) cm	Kg
60	80x120x111	172

25 m		GF80277310	
(LxWxH) cm Ø 37x12,5			
Pcs 1	kg 3,6	8 004779 040634	

PALLET		
Pcs	Box (LxWxH) cm	Kg
48	80x120x115	196

25 m		GF80277312	
(LxWxH) cm Ø 36x12			
Pcs 1	kg 4	8 004779 040665	

PALLET		
Pcs	Box (LxWxH) cm	Kg
42	80x120x111	191

+70% KIT RECYCLED PLASTIC READY

3 jet

Ready kit made with + 70% recycled plastic:
 • 1x open connector • 1x connector Acquastop • 1x tap connector 3/4+1/2 • 1x ergonomic nozzle 3 jet

Hoses pipe and kit sizes: a tolerance +/- 15mm to be considered





“AquaBag” display stand

Self-supporting cardboard display with crowner. It is supplied assembled and completed with products.

It contains: 18 pcs AquaBag

Opened dimensions:

cm 72 x 54 x 140 h

GF80600022		
Box (LxWxH) cm 72x54x102,5		
 Pcs 18	EAN	
Kg 44,10	8004779035975	



“SUNNY STYLE” display

Floor-standing dispenser box of small dimensions completed of panel with illustrated instructions.

- 4 “Sunny Style” shower boxes
- Dimensions cm 62 x 62 x 171

GF80606927		
Box (LxWxH) cm 62x62x95		
In Store (LxWxH) cm 62x62x171		
Kg 29,5	Pcs 4	EAN 8004779038334

Sustainable packaging

The graphic substrates, packaging and merchandising fixtures are made of sustainable sourced cardboard, and can be recycled together with waste paper.

MERCHANDISING



Carton Display

1/3 pallet

Box (LxWxH)

cm 80x40x105

In Store (LxWxH)

cm 80x40x145



Floor Totem

GF21001229

Box (LxWxH)

cm 52x152x10

In Store (LxWxH)

cm 56x56x152

Ø 1/2
12,5 mm

Ø 5/8
15 mm

Ø 3/4
19 mm

SALVIA DISPLAY

15 m	GF80607315
Kg 50	Pcs 21 EAN 8004779040672

15 m	GF80607317
Kg 54	Pcs 20 EAN 8004779040702

15 m	GF80607319
Kg 56	Pcs 14 EAN 8004779040733

25 m	GF80607316
Kg 63	Pcs 16 EAN 8004779040689

25 m	GF80607318
Kg 69	Pcs 16 EAN 8004779040719

25 m	GF80607320
Kg 64	Pcs 10 EAN 8004779040740

SALVIA KIT DISPLAY

15 m	GF80607321
Kg 57	Pcs 21 EAN 8004779040764

15 m	GF80607322
Kg 57	Pcs 20 EAN 8004779040788

15 m	GF80607323
Kg 58	Pcs 14 EAN 8004779040801

MIXCOLOR DISPLAY

15 m	GF80257300
Kg 50	Pcs 1 21pz. 7x salvia - 7x lime - 7x fuxia

15 m	GF80257303
Kg 54	Pcs 1 20pz. 7x salvia - 7x lime - 6x fuxia

25 m	GF80257301
Kg 63	Pcs 1 16pz. 6x salvia - 6x lime - 4x fuxia

25 m	GF80257304
Kg 69	Pcs 1 16pz. 6x salvia - 6x lime - 4x fuxia

MIX COLOR KIT DISPLAY

15 m	GF80257309
Kg 54	Pcs 1 21pz. 7x salvia - 7x lime - 7x fuxia

15 m	GF80257311
Kg 57	Pcs 1 20pz. 7x salvia - 7x lime - 6x fuxia

